

**CITY OF TEMPE
DEVELOPMENT REVIEW COMMISSION**

**Meeting Date: 04/09/2013
Agenda Item: 3**

ACTION: Request for a Development Plan Review consisting of the remodel of an existing restaurant building for THE MISSION@ MINDER BINDERS located at 715 South McClintock Drive. The applicant is Paramount Design, LLC.

FISCAL IMPACT: The planned development will result in collection of the standard development fees, calculated according to the approved fee structure at the time of permit issuance.

RECOMMENDATION: Staff -Approval subject to conditions

BACKGROUND INFORMATION: The Mission@ Minder Binders (PL120259) is a remodel and reuse of the existing Minder Binder building located on the east side of McClintock Drive and north of University Drive. The new owner is proposing to incorporate the current barn style building design into a mission design building with a courtyard. The site will be upgraded with new landscape material. The request includes the following:

DPR07020 Development Plan Review including site plan, building elevations and landscape plan

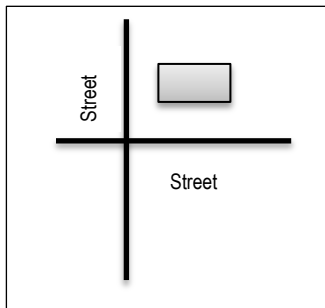

Property Owner	GIGBIGPACAZ, LLC
Applicant	Howard Li
Current Zoning District	CSS- Commercial Shopping and Services
Gross/Net site area	1.1635 Net acre//
Total Building area	16908 s.f. (including storage bldg. and courtyard)
Lot Coverage	19 % (50% maximum allowed)
Building Height	35 ft (35 ft maximum allowed)
Building Setbacks	+37' front, +0' side, +28' rear (0, 0, 10 min.)
Landscape area	25% (15% minimum required)
Vehicle Parking	73 spaces on site 60 shared with surrounding properties; (132 min. required)
Bicycle Parking	15 spaces (14 required)

ATTACHMENTS: Development Project File

STAFF CONTACT: Sherri Lesser. Senior Planner (480-350-8486)

Department Director: Lisa Collins, Interim Community Development Director
 Legal review by: N/A
 Prepared by: Sherri Lesser, Senior Planner



COMMENTS:

The property has been occupied with a freestanding restaurant building since 1971 as "Minder Binders". The restaurant went out of business over a decade ago and the site has been vacant. The new owner will incorporate the first floor seating area into their new restaurant and the second floor will be unoccupied. Due to the existing kitchen's noncompliance with current building code; the new owner is opting to build a separate structure in front of the existing building and surround the addition behind walls in an interior courtyard.

This application includes a modification to the site including new building façade in a Santa Fe Mission style with an enclosed courtyard, a new refuse enclosure, upgraded landscaping and lighting. The building area will be 10046 sf of indoor restaurant space including the new kitchen, 4282 s.f. of outdoor patio area and 2580 sf of office/storage space. The applicant is requesting that the Development Review Commission take action on the site plan, building elevations and landscape plan; no further planning entitlements are required.

PUBLIC INPUT

No neighborhood meeting required.

PROJECT ANALYSIS**BUILDING ELEVATIONS**

The new 16,908 square foot building and courtyard is oriented in an east to west configuration perpendicular to the McClintock Road frontage; relatively the same location as the existing Minder Binders but extends closer to the street and is designed in a Santa Fe' Mission style. The new exterior is a stucco finish with stone accents surrounding the faux windows and in random locations on the elevation. The roof will be upgraded to a rust copper color metal roof. The main entrance from the street will be accessible from the McClintock Drive frontage. The original Minder Binder restaurant building required a total of 99 parking spaces which were provided on site. Based on current ordinance requirements and the addition of an outdoor patio and office space, the site requirement for parking is 132 spaces. The applicant has processed a shared parking model with adjacent property owners to address the parking deficiency. The color scheme for the building base is a combination of light tan colors. The stone surrounding windows will be in earth tones. The metal roof is a rust copper color.

Staff recommends approval with a couple modifications to the front building elevation which will enhance the Mission style design in character with the original theme. A center focal point shall be established on the west (front) elevation to line up with the raised arch and cross located at the top center of the building elevation. A focal feature may be accomplished by either centering the overhead door opening to align with the arch or create a depression in the wall plane, for an area, which lines up the width distance under the arch. The roll up door entrance should be changed to a door which slides open horizontally rather than overhead; this change is a character of a mission style design.

LANDSCAPE

The proposed plan upgrades the landscape material at the street front, around the building and in the parking lot islands. The plant palette is a combination of low water use plants and trees.

Section 6-306 D Approval criteria for Development Plan Review

1. Placement, form, and articulation of buildings and structures provide variety in the streetscape; the new building is oriented to the street with varying building forms to enhance visual character.
2. Building design and orientation, together with landscape, combine to mitigate heat gain/retention while providing shade for energy conservation and human comfort. There is minimal glazing on the south exposure. The outdoor patio will be surrounded with buildings and walls.
3. Materials are quality, providing detail appropriate with their location and function while complementing the surroundings; the materials are compatible to the surrounding aesthetic which is primarily industrial buildings.

- 4 Buildings, structures, and landscape elements are appropriately scaled, relative to the site and surroundings; as modified the building scale fits the site.
5. Large building masses are sufficiently articulated so as to relieve monotony and create a sense of movement, resulting in a well-defined base and top, featuring an enhanced pedestrian experience at and near street level; the proposed modifications will enhance the mission style design.
6. Building facades provide architectural detail and interest overall with visibility at street level (in particular, special treatment of windows, entries and walkways with particular attention to proportionality, scale, materials, rhythm, etc.) while responding to varying climatic and contextual conditions; the building is a combination textured and metal finishes in earth tone and tan color scheme.
7. Plans take into account pleasant and convenient access to multi-modal transportation options and support the potential for transit patronage; patio areas connect to the street front.
8. Vehicular circulation is designed to minimize conflicts with pedestrian access and circulation; the building is being remodeled in place. All driveways and on site circulation patterns are per the existing site layout.
9. Plans appropriately integrate Crime Prevention Through Environmental Design principles such as territoriality, natural surveillance, access control, activity support, and maintenance; providing staff closer to the street and with views of the parking lot will provide more surveillance of the site during business hours. The new building will meet lighting and design requirements for CPTED. The Police Department is seeking the addition of surveillance cameras to the exterior to view the side and rear parking areas.
10. Landscape accents and provides delineation from parking, buildings, driveways and pathways; landscape upgrades been added to the parking area.
11. Lighting will be compatible with the proposed building and adjoining building and uses, and will not create negative effects.

Conclusion

Based on the information provided and the above analysis, staff recommends approval of the requested Development Plan Review. This request meets the required criteria and will conform to the conditions.

REASONS FOR APPROVAL:

1. The project meets the intent of the General Plan elements.
2. The project meets the development standards required by the Zoning and Development Code.
3. The proposed project meets the approval criteria for a Development Plan Review.

CONDITIONS OF APPROVAL:

EACH NUMBERED ITEM IS A CONDITION OF APPROVAL. THE DECISION-MAKING BODY MAY MODIFY, DELETE OR ADD TO THESE CONDITIONS.

DPR13058

CONDITIONS OF APPROVAL

General

1. Process a subdivision plat to remove existing lot ties and combine all to one lot prior to issuance of Certificate of Occupancy.

Site Plan

2. Utility equipment boxes for this development shall be finished in a neutral color (subject to utility provider approval) that compliments the coloring of the buildings.

Floor Plans

2. Public Restroom Security:
 - a. Lights in restrooms:
 - 1) Provide 50% night lights
 - 2) Activate by automatic sensors, key or remote control mechanism
 - b. Single user restroom door hardware:
 - 3) Provide a key bypass on the exterior side

Building Elevations

3. The materials and colors are approved as presented:
 - Base- Stucco Finish "Weathered Adobe" tan
 - Metal Roof- Rust Copper Color
 - Stone Accents- Gray and Earth tonesProvide main colors and materials with a light reflectance value of 75 percent or less. Specific colors and materials, additions or modifications may be submitted for review during building plan check process.
4. For roof access provide internal ladder access fully screened at parapet.
5. Minimize visible, external features, such as overflows, and where needed design these to enhance the architecture of the building.
6. Modify roll up door to a horizontal door opening utilizing wood or ornamental metal gate material.
7. Modify appearance of west elevation to line up entrance under arch feature or create a depression in wall place for visual character consistent with mission style design, details to be approved by staff in planning plan check process.

Lighting

8. This project shall follow requirements of ZDC Part 4, Chapter 8, Lighting, for entire site and building unless otherwise conditioned.

Landscape

9. The plant palette is approved as proposed and specified on the landscape plan. Any additions or modifications may be submitted for review during building plan check process.
10. Irrigation notes:
 - a. Provide dedicated landscape water meter.
 - b. Provide pipe distribution system of buried rigid (polyvinylchloride), not flexible (polyethylene). Use of schedule 40 PVC mainline and class 315 PVC 1/2" feeder line is acceptable. Class 200 PVC feeder line may be used for sizes greater than 1/2". Provide details of water distribution system.
 - c. Locate valve controller in a vandal resistant housing.
 - d. Hardwire power source to controller (a receptacle connection is not allowed).
 - e. Controller valve wire conduit may be exposed if the controller remains in the mechanical yard.
 - f. Repair existing irrigation system (on site or in the adjacent public right of ways) where damaged by work of this project. Provide temporary irrigation to existing landscape (on site or in these frontages) for period of time that irrigation system is out of repair. Design irrigation so (existing plants on site or in frontages) is irrigated as part of the reconfigured system at the conclusion of this construction.

11. Top dress planting areas with a rock or decomposed granite application. Provide rock or decomposed granite of 2" uniform thickness. Provide pre-emergence weed control application and do not underlay rock or decomposed granite application with plastic.

Signage

12. Provide address sign(s) on the building elevation facing the street to which the property is identified.
 - a. Conform to the following for building address signs:
 - 1) Provide street number only, not the street name
 - 2) Compose of 12" high (standard for commercial), individual mount, metal reverse pan channel characters.
 - 3) Self-illuminated or dedicated light source.
 - 4) Coordinate address signs with trees, vines, or other landscaping, to avoid any potential visual obstruction.
 - 5) Do not affix number or letter to elevation that might be mistaken for the address.
 - b. Utility meters shall utilize a minimum 1" number height in accordance with the applicable electrical code and utility company standards.

CODE/ORDINANCE REQUIREMENTS:

THE BULLETED ITEMS REFER TO EXISTING CODE OR ORDINANCES THAT PLANNING STAFF OBSERVES ARE PERTINENT TO THIS CASE. THE BULLET ITEMS ARE INCLUDED TO ALERT THE DESIGN TEAM AND ASSIST IN OBTAINING A BUILDING PERMIT AND ARE NOT AN EXHAUSTIVE LIST.

Specific requirements of the **Zoning and Development Code** (ZDC) are not listed as a condition of approval, but will apply to any application. To avoid unnecessary review time and reduce the potential for multiple plan check submittals, become familiar with the ZDC. Access the ZDC through www.tempe.gov/zoning or purchase from Community Development.

SITE PLAN REVIEW: Verify all comments by the Public Works Department, Community Development Department, and Fire Department given on the Preliminary Site Plan Review. If questions arise related to specific comments, they should be directed to the appropriate department, and any necessary modifications coordinated with all concerned parties, prior to application for building permit. Construction Documents submitted to the Building Safety Division will be reviewed by planning staff to ensure consistency with this Design Review approval prior to issuance of building permits.

BUILDING ELEVATIONS

All mechanical equipment shall be fully screened on all elevation sides above a horizontal plane per Section 4-405.

STANDARD DETAILS:

Access to Tempe Supplement to the M.A.G. Uniform Standard Details and Specifications for Public Works Construction, at this link: www.tempe.gov/index.aspx?page=2147 or purchase book from the Public Works Engineering Division.

Access to refuse enclosure details and all other Building Safety forms at this link: www.tempe.gov/index.aspx?page=1033. The enclosure details are under Civil Engineering & Right of Way.

SECURITY REQUIREMENTS

Design building entrance(s) to maximize visual surveillance of vicinity. Limit height of walls or landscape materials, and design columns or corners to discourage opportunity for ambush opportunity. Maintain distances of 20'-0" or greater between a pedestrian path of travel and any hidden area to allow for increased reaction time and safety.

Follow the design guidelines listed under appendix A of the Zoning and Development Code. In particular, reference the CPTED principal listed under A-II Building Design Guidelines (C) as it relates to the location of pedestrian environments and places of concealment.

Provide a security vision panel at service and exit doors (except to rarely accessed equipment rooms) with a 3" wide high strength plastic or laminated glass window, located between 43" and 66" from the bottom edge of the door.

ENGINEERING:

Clearly indicate property lines, the dimensional relation of the buildings to the property lines and the separation of the buildings from each other. Verify location of any easements, or property restrictions, to ensure no conflict exists with the site layout or foundation design.

REFUSE:

Contact Public Works Sanitation Division to verify that vehicle maneuvering and access to the enclosure is adequate.

PARKING SPACES:

Verify conformance of accessible vehicle parking to the Americans with Disabilities Act of 1990 (42 U.S.C.A. §12101 ET SEQ.) and the Code of Federal Regulations Implementing the Act (28 C.F.R., Part 36, Appendix A, Sections 4.1 and 4.6). Refer to Standard Detail T-360 for parking layout and accessible parking signs.

At parking areas, provide demarcated accessible aisle for disabled parking.

Distribute bike parking areas nearest to main entrance(s). Provide parking loop/rack per standard detail T-578. Provide 2'-0" by 6'-0" individual bicycle parking spaces. One loop may be used to separate two bike parking spaces. Provide clearance between bike spaces and adjacent walkway to allow bike maneuvering in and out of space without interfering with pedestrians, landscape materials or vehicles nearby.

LIGHTING:

Design site security light in accordance with requirements of ZDC Part 4 Chapter 8 (Lighting) and ZDC Appendix E (Photometric Plan).

Indicate the location of all exterior light fixtures on the site, landscape and photometric plans. Avoid conflicts between lights and trees or other site features in order to maintain illumination levels for exterior lighting.

SIGNS:

Separate Development Plan Review process is required for signs in accordance with requirements of ZDC Part 4 Chapter 9 (Signs). Obtain sign permit for identification signs. Directional signs (if proposed) may not require a sign permit, depending on size. Directional signs are subject to review by planning staff during plan check process.

HISTORY & FACTS:

February 22, 1973- The City Council approved the zoning amendment of this site from AG to C-1, Neighborhood Commercial.

September 16, 1972- Building Permit issued for a new restaurant building for Minder Binders Restaurant including a two story building, parking lot and sign.

ZONING AND DEVELOPMENT CODE REFERENCE:

Section 6-306, Development Plan Review

THE MISSION @ MINDER BINDERS

PL120259

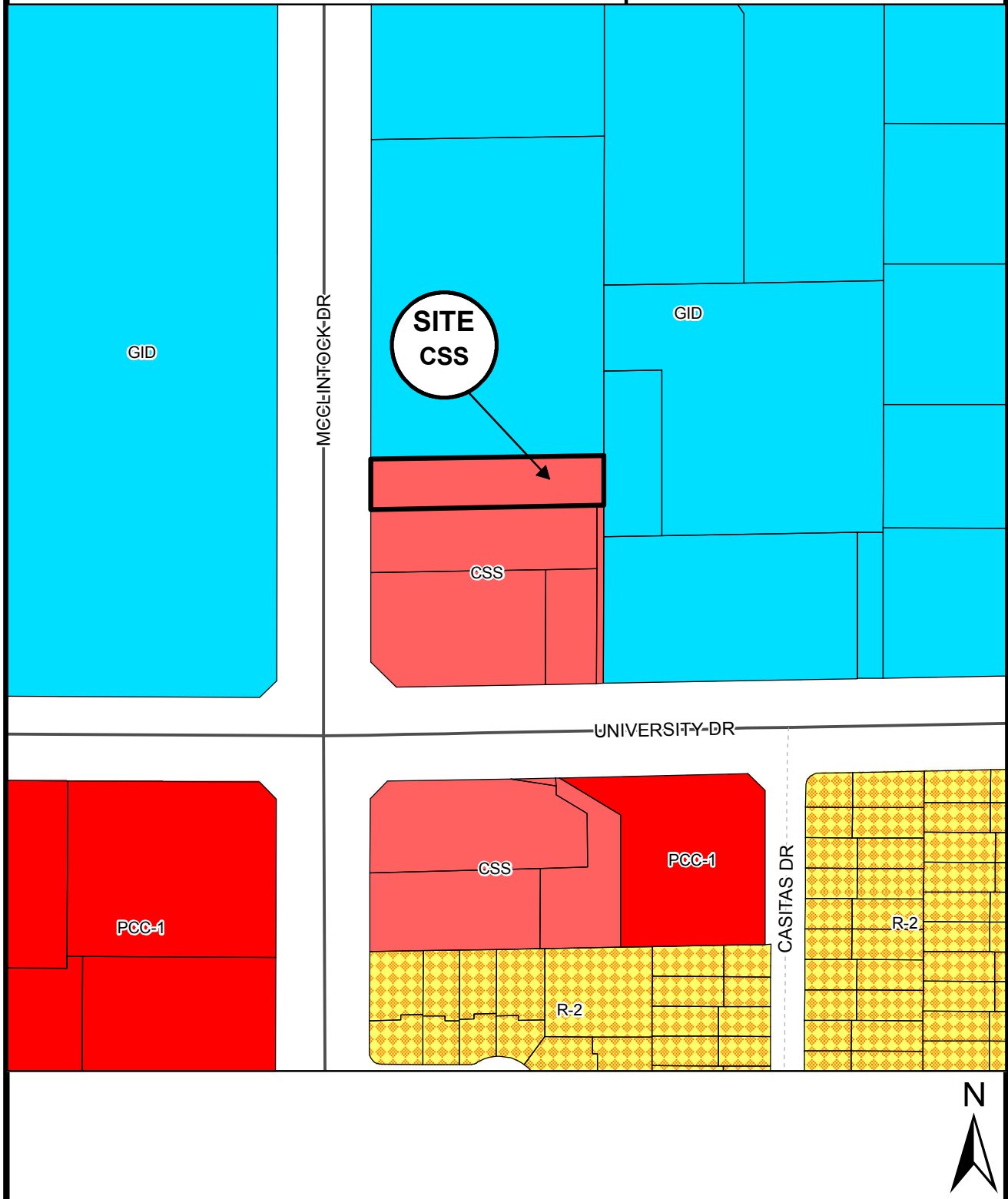

Location Map

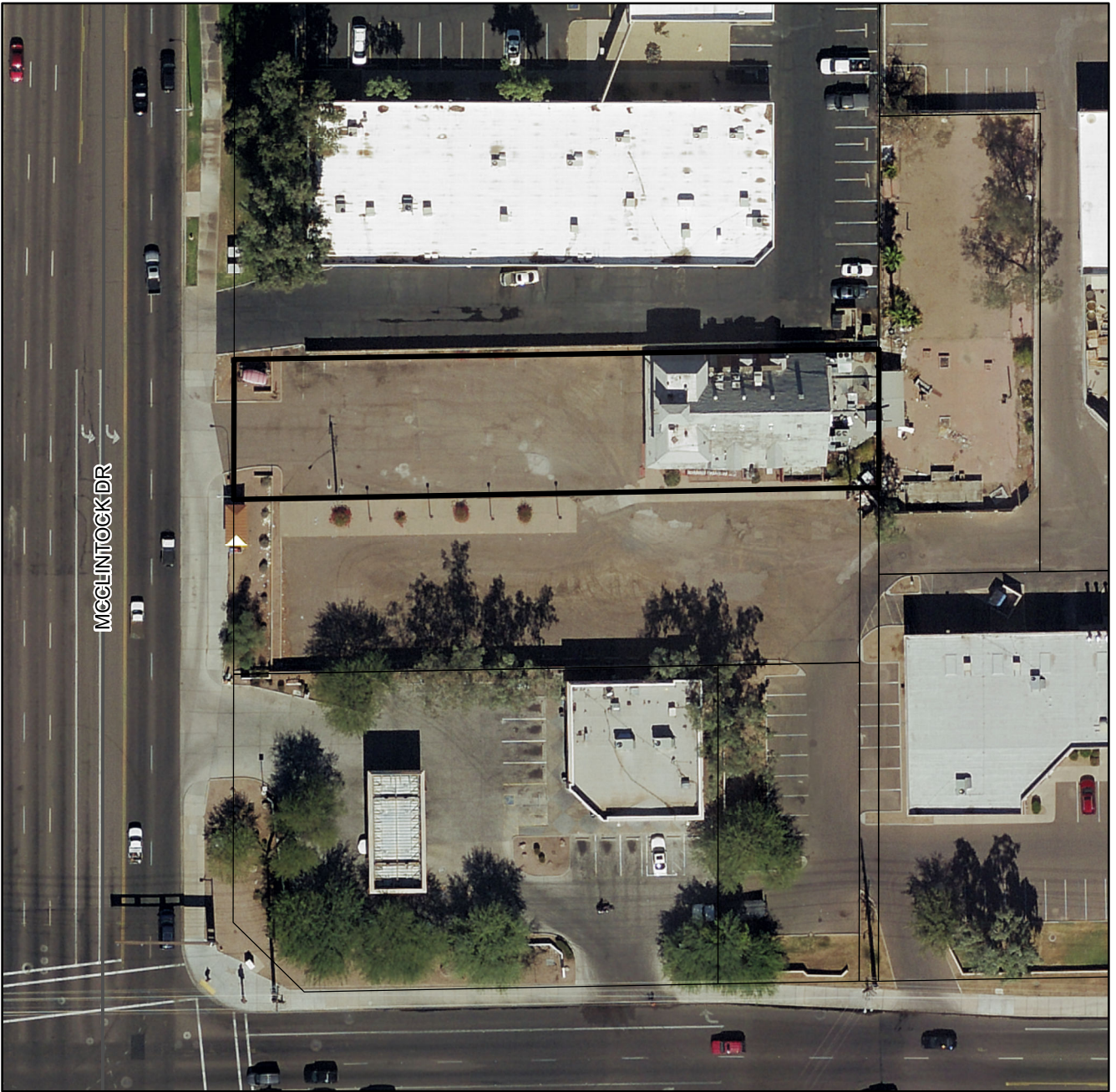

THE MISSION @ MINDER BINDERS (PL120259)

Project: Minder Binder
715 S. McClintock Dr.
Tempe, AZ 85257

PROJECT OVERVIEW

The subject property is located on the east side of McClintock Dr. just north of University Dr. & encompasses approximately 1.1635 acres (the property). This application request approval of the Community Development Planning Department. The site has an attractive and prominent location within the city of Tempe and has been established since 1971.

The overall goal of Minder Binder is to bring back part of Tempe history and restore the original building along with expanding on the design and upgrading the exterior elevations with a santa fe style façade to bring a part of Arizona history back to life. Built in 1971 Minder Binder in one of Tempe's still standing landmarks.

ADJACENT PROPERTIES

The property is bordered by a Circle K on the south property with surrounding industrial bordering the east and north property lines. Tempe being a college town the Minder Binder project is carefully designed to be compatible with all the adjacent and proximate land uses while bring a pleasant and architecturally appealing building to the existing area by the use of materials such as concrete, stucco, stone veneer and metal. The community of the entire development will be accommodated with the addition of plant material along street frontage providing shade for bystanders.

CONCEPTUAL SITE PLAN

The proposed project will consist of the addition on the existing two story building on site. The expansion will sit on 1.1635 acres consisting of four lots. The proposed building addition will be two stories and have a covered patio addition. The proposed addition will have a santa fe style look and feel and utilize dual pane glazing and mature trees to insure energy conservation and comfort as part of the integrated design. The building is capped by a metal seamed along pitched gable roof with thermoplastic polyolefin single ply membrane roofing to provide architectural appeal by introducing different elements.

The existing site is now being redesigned to accommodate the expansion of the existing building. Additional parking has been added to insure adequate parking is provided along with bicycle racks to accommodate the patrons that do not drive to site. A bus stop is to remain along McClintock and the addition of ada path of travel and sidewalk has been added to insure ease of travel from street frontage. The path of travel has been adequately lighted by the use of light poles in such a manner as to note create negative effects. The Americans With Disability Act Conformance has been adhered in the development of the

proposed site additions & adequate ada parking has been provided along with clearly lite path of travel along foundation planting.

All utilities on site are ran underground. Building & landscape material is proposed in such a way that it is proportionate to the existing site. Landscape accents have been provided in parking lot and setbacks to provide shade and an appealing entrance into site along McClintock. The use of small plant material and maintenance will be utilized to insure safety of customers at site.

VEHICULAR ACCESS AND CIRCULATION

Driveway locations, access points and internal roads have been located in a manner that will be compatible with the current uses associated with the Downtown Tempe to the west. With two existing on site one existing onto McClintock Dr. and one exiting onto University Dr. Patrons have the option to access site from multiple locations. All driveways meet the spacing standards and criteria as set forth by the city.

Foundation hardscape and clearly labeled ada access paths that are adequately lighted have been provided to insure vehicular circulation in a way to minimize conflicts with pedestrians access. The Tempe Pedestrian and Bicycle Facility Guidelines have been taken into consideration in construction of site plan.

BUILDING

The santé fe adobe style gives the appearance as if the structure was erected from the earth. The building has been broken down into smaller spaces with the addition of stairs & metal railing on the exterior of the building are provided help separate the floors and create multiple levels with architectural elements to insure a more human scale from the sidewalk.

Between doors and windows the addition of large roll-up doors have been used to help create an open feeling and increase the security of adjacent outdoor spaces. The addition of roll-up doors and large windows with customized metal gates contribute to the public spaces making them more attractive.

Sincerely ,

Howard Li

2/19/13
Date

NOTES

1. SIGNS ARE APPROVED BY SEPARATE PERMIT.
2. DUMPSTERS AND MECHANICAL EQUIPMENT WILL BE SCREENED FROM THE PUBLIC VIEW.
3. WALLS OVER 6' HIGH APPROVED BY SEPARATE PERMIT.
4. PARKING WILL BE PAVED AS SPECIFIED BY THE PINAL COUNTY PUBLIC WORKS DEPARTMENT AS REFERENCED IN PINAL COUNTY ZONING ORDINANCE ARTICLE 21.
5. PARKING WILL BE WITHIN 600 FEET OF BUILDING.
6. ROOFTOP MECHANICAL EQUIPMENT WILL BE SCREENED FROM VIEW.

PROJECT DATA

ARCHITECT
 PARAMOUNT DESIGN AND CONSULTING LLC
 HOWARD LI
 3949 N. ARDOLLES CIRCLE, MESA, AZ 85207
 PH: 602-882-5609 HWRLI@PDC.COM

PROJECT NAME
 THE MISSION AT MINDER BINDER

SITE ADDRESS
 715 S. MCCLINTOCK DR.
 TEMPE, AZ

LEGAL DESCRIPTION
 LOCATED IN A PORTION OF THE
 TOWNSHIP 1 NORTH, RANGE 4 EAST OF
 THE GILA AND SALT RIVER BASE AND
 MERIDIAN, MARICOPA COUNTY, ARIZONA
 715 S. MCCLINTOCK DRIVE

API
 132-40-002K, 005K, 005K & 009D

ZONING
 CSS & GD

NET SITE AREA
 50680 SF (1.1635 AC.)

NUMBER OF TOTAL LOTS
 4

BUILDING LOT COVERAGE
 19.82 % (10946 SF)

BUILDING HEIGHT
 35' MAX.

NUMBER OF STORIES
 2

TYPE OF CONSTRUCTION PER BUILDING CODE
 VB / SPRINKLERED

AUTOMATIC FIRE EXTINGUISHING SYSTEM
 YES

PROPOSED USES
 A2

SETRBACK	0'
FRONT PARKING	20'
SIDE BUILDING WALL COMMON WALL	0'
REAR- BUILDING WALL	10'
STREET SIDE PARKING	0'
	20'

PARKING CALCULATIONS

NEW RESTAURANT IF	127 SF	75 *	750
NEW OFFICE BLDG IF	98 SF	75 *	131
EXISTING RESTAURANT IF	208 SF	75 *	432
EXISTING OFFICE BLDG IF	208 SF	75 *	242
NEW OUTDOOR DINING PATIO	109	100 *	690
TOTAL	1599	996 *	1928
NEW KITCHEN IF	121 SF	75 *	124
NEW STORAGE IF	121 SF	75 *	124
TOTAL	242 SF	151 *	242
NEW RESTROOM IF	300 SF	75 *	476
NEW BWP & KITCHEN IF	100 SF	75 *	44
NEW STORAGE IF	100 SF	75 *	338
NEW RESTROOM IF	200 SF	75 *	44
NEW OUTDOOR UNCOVERED COURT/YARD AREA	3000 SF	100 *	200
TOTAL	3600 SF	150 *	3600

GRAND TOTAL
 TOTAL PARKING SPACES PROVIDED: 73

BICYCLE PARKING CALCULATIONS

RESTAURANT	1137 SF	1000 *	1137
OFFICE	404 SF	2000 *	79
OFFICE	208 SF	1000 *	39
GRAND TOTAL			1195
TOTAL BICYCLE PARKING SPACES PROVIDED			1195

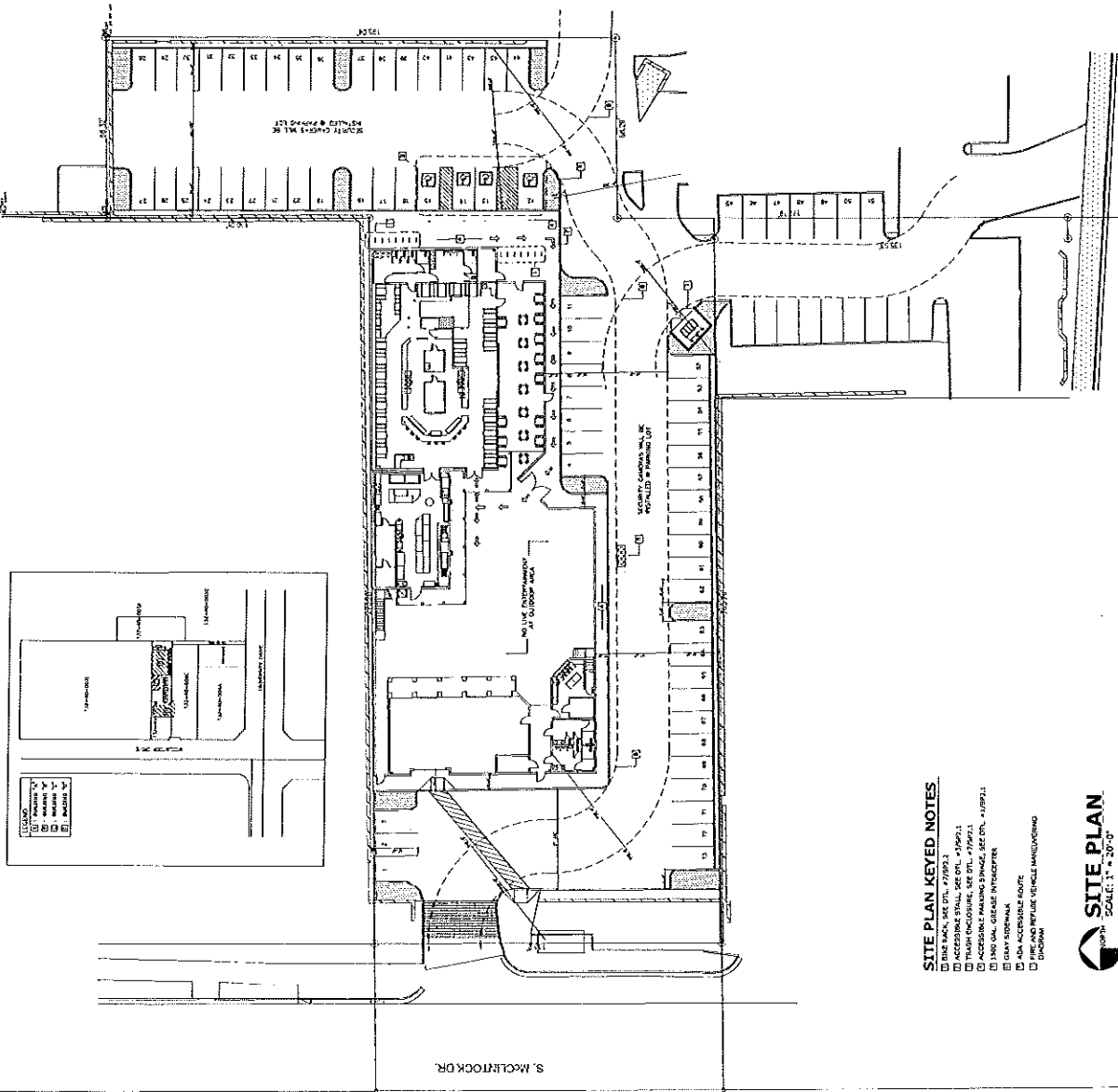

- SITE PLAN KEYED NOTES**
1. ALL DIMENSIONS ARE IN FEET UNLESS NOTED OTHERWISE.
 2. ACCESSIBLE ROUTE SEE DET. #7789.1
 3. TRASH ENCLOSURE SEE DET. #7789.1
 4. ACCESSIBLE PARKING SPACES SEE DET. #1199.1
 5. 1500 GAL. GREASE INTERCEPTOR
 6. GRASS SIDEWALK
 7. ADA ACCESSIBLE ROUTE
 8. NEW TRUCK TRAILER MANEUVERING ZONE



THE MISSION AT MINDER BINDER
 PROPOSED RESTAURANT FOR:
 715 S. MCCLINTOCK DR.
 TEMPE, AZ

SITE PLAN
 SCALE: 1/4" = 1'-0"
 DATE: 02/13/13
 DRAWN BY: H. L.
 CHECKED BY: H. L.
 PROJECT NO.:

PDC
 PARAMOUNT DESIGN & CONSULTING
 2900 North 40th Street, Suite 1000, Tempe, Arizona 85281
 T: 602-882-5609 | F: 602-795-6017

PROPOSED RESTAURANT FOR:
THE MISSION AT MINDER BINDER
 715 S. MCCLINTOCK DR.
 TENCPE, AZ



PARAMOUNT DESIGN & CONSULTING
 1400 North 44th Ave., Suite 100, Phoenix, AZ 85018
 Tel: 602-842-9088 Fax: 602-842-8417

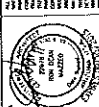

P.D. COLLINS
 PROFESSIONAL ARCHITECT
 STATE OF ARIZONA
 ARCHITECT NO. 19720
 LICENSE EXPIRES 06/30/2012

1st FLOOR PLAN

AS NOTED	02/19/13	A1.1
DATE	PROJECT	SCALE
1/8" = 1'-0"		

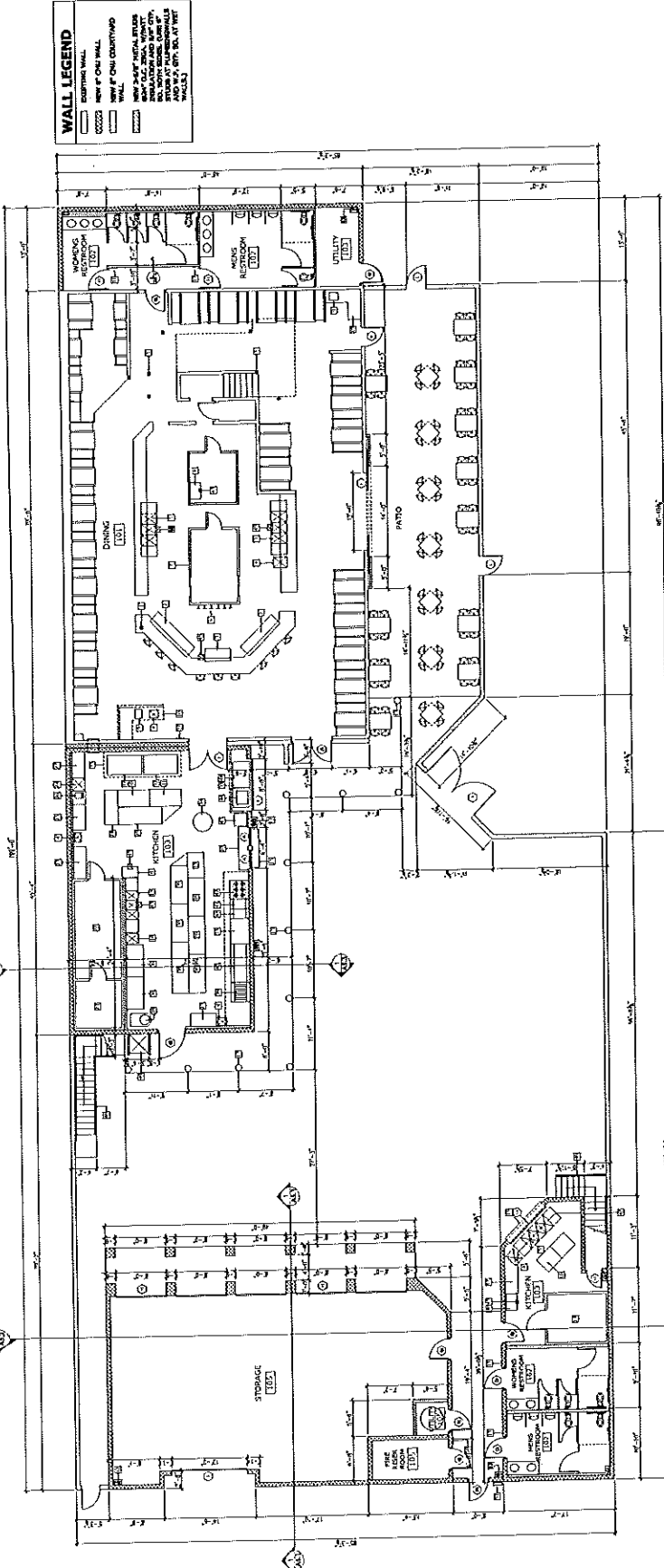

- WALL LEGEND**
- EXISTING WALL
 - NEW 1/2" CMU WALL
 - 1/2" GYPSUM BOARD
 - 5/8" CONCRETE
 - 1/2" GYPSUM BOARD OVER 1/2" CONCRETE
 - 1/2" GYPSUM BOARD OVER 5/8" CONCRETE
 - 1/2" GYPSUM BOARD OVER 1/2" CONCRETE WITH 1/2" GYPSUM BOARD OVER 5/8" CONCRETE
 - 1/2" GYPSUM BOARD OVER 1/2" CONCRETE WITH 1/2" GYPSUM BOARD OVER 5/8" CONCRETE
 - 1/2" GYPSUM BOARD OVER 1/2" CONCRETE WITH 1/2" GYPSUM BOARD OVER 5/8" CONCRETE
 - 1/2" GYPSUM BOARD OVER 1/2" CONCRETE WITH 1/2" GYPSUM BOARD OVER 5/8" CONCRETE

- INTERIOR FINISH SCHEDULE**
- 101 FLOOR: STAINER CONCRETE
CEILING: OPEN CEILING
BASE: # RUBBER CONVE. BASE
WALLS: SMOOTH TEXTURE, PAINTED C/P. BO.
 - 102 FLOOR: CERAMIC TILE
CEILING: OPEN CEILING
BASE: CERAMIC TILE COVE
WALLS: CERAMIC TILE TO 4'-0" SUBROUND
C/P. BO. PAINTED HIGH GLOSS ABOVE 4'-0"
 - 103 FLOOR: QUARRY TILE
CEILING: C/P. BO. PAINTED / SMOOTH WASHABLE
BASE: VINYL BASE / PHOTOY. EQUIPMENT
WALLS: SMOOTH TEXTURE, PAINTED C/P. BO.
 - 104 FLOOR: CARPET
CEILING: C/P. BO. PAINTED
BASE: VINYL COVERED
WALLS: SMOOTH TEXTURE, PAINTED C/P. BO.
 - 105 FLOOR: SEALED CONCRETE
CEILING: C/P. BO. CEILING
BASE: VINYL COVERED
WALLS: C/P. BO. PAINTED

- KEYED DOORS SCHEDULE**
- ⊙ DOUBLE 3070 S.C. DOOR W/ PANIC HARDWARE
 - ⊙ 3070 S.C. DOOR W/ PUSH/PULL HARDWARE
 - ⊙ 12'-0" WIDE POCKET DOOR
 - ⊙ 3070 S.C. DOOR W/ PUSH-PULL HARDWARE
 - ⊙ 3070 PAIR ALUM. DOUBLE SWING DOOR
 - ⊙ 8'-0" WIDE DOOR
 - ⊙ 3070 S.C. DOOR W/ LEVER HARDWARE
 - ⊙ 12' X 7' SECTIONAL ROLL UP DOOR
 - ⊙ PAIR 4070 S.C. DOOR W/ PANIC HARDWARE
 - ⊙ 3070 TEMP. GLASS DOOR W/ PANIC HARDWARE
 - ⊙ 3070 METAL GATE W/ PANIC HARDWARE
 - ⊙ 3070 S.C. DOOR W/ PANIC HARDWARE (1) LOWERED VENTS T & B.
 - ⊙ 8' X 6' SECTIONAL ROLL UP DOOR

- 1st FLOOR PLAN KEYED NOTES**
- 1 WALK-IN FREEZER, 0'-0" X 8'-0"
 - 2 WALK-IN COOLER, 8'-0" X 16'-0"
 - 3 SHELVING
 - 4 HOT TUB
 - 5 DISHWASHER W/ BACKFLOW DEVICE
 - 6 FLOOR SINK
 - 7 2'-0" GUARD RAIL
 - 8 STAIR HARP RAIL
 - 9 REFRIGERATED CONDIMENT TABLE
 - 10 FRIE RISEK ROOM SIGN, SEE DTL. #2/AA.1
 - 11 KNOX BOX, SEE DTL. #2/AA.3
 - 12 WALK-IN COOLER, 0'-0" X 8'-0"
 - 13 WALK-IN FREEZER, 0'-0" X 8'-0"
 - 14 FLOOR SINK
 - 15 DISHWASHER
 - 16 5.5. DOUGH PREP TABLE
 - 17 SALAD PREP TABLE, 4'-0" X 8'-0"
 - 18 PIZZA CUT TABLE, 4'-0" X 8'-0"
 - 19 PIZZA OVEN, DECK TYPE
 - 20 4' X 12' TYPE II HOOD
 - 21 COPY ISLAND
 - 22 PASTRY CASE
 - 23 STAINLESS STEEL PREP TABLE
 - 24 POST OCCUPANCY SIGN, SEE DTL. #2/AA.1
 - 25 MIXER
 - 26 CHAR BROILER
 - 27 GRILL
 - 28 12" ROUND VEGA PODS
 - 29 PASS THROUGH COUNTER
 - 30 STAINLESS STEEL WORKTOP
 - 31 KITCHEN / J-COMM. ROOM SIGN, SEE DTL. #2/AA.1
 - 32 STAINLESS STEEL PASS-THRU COUNTER

1st FLOOR PLAN
 SCALE: 1/8" = 1'-0"

- KEYED WINDOWS SCHEDULE**
- ⊙ 2'-0" W X 4'-0" H WINDOW

PROPOSED RESTAURANT FOR:
THE MISSION AT MINDER BINDER
 715 S. McCLINTOCK DR.
 TEMPE, AZ

NO.	REVISION / MARK	DATE

PDC
 PARAMOUNT DESIGN & CONSULTING
 100 North Ardenway Cir., Mesa, Arizona 85207
 760-240-5688 F: 480-719-9611

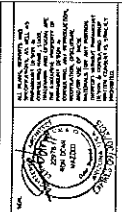

2nd FLOOR PLAN

DATE	AS NOTED
NO.	02/19/13
BY	W.Y.
CHECKED	H.L.
PROJECT	A1.2

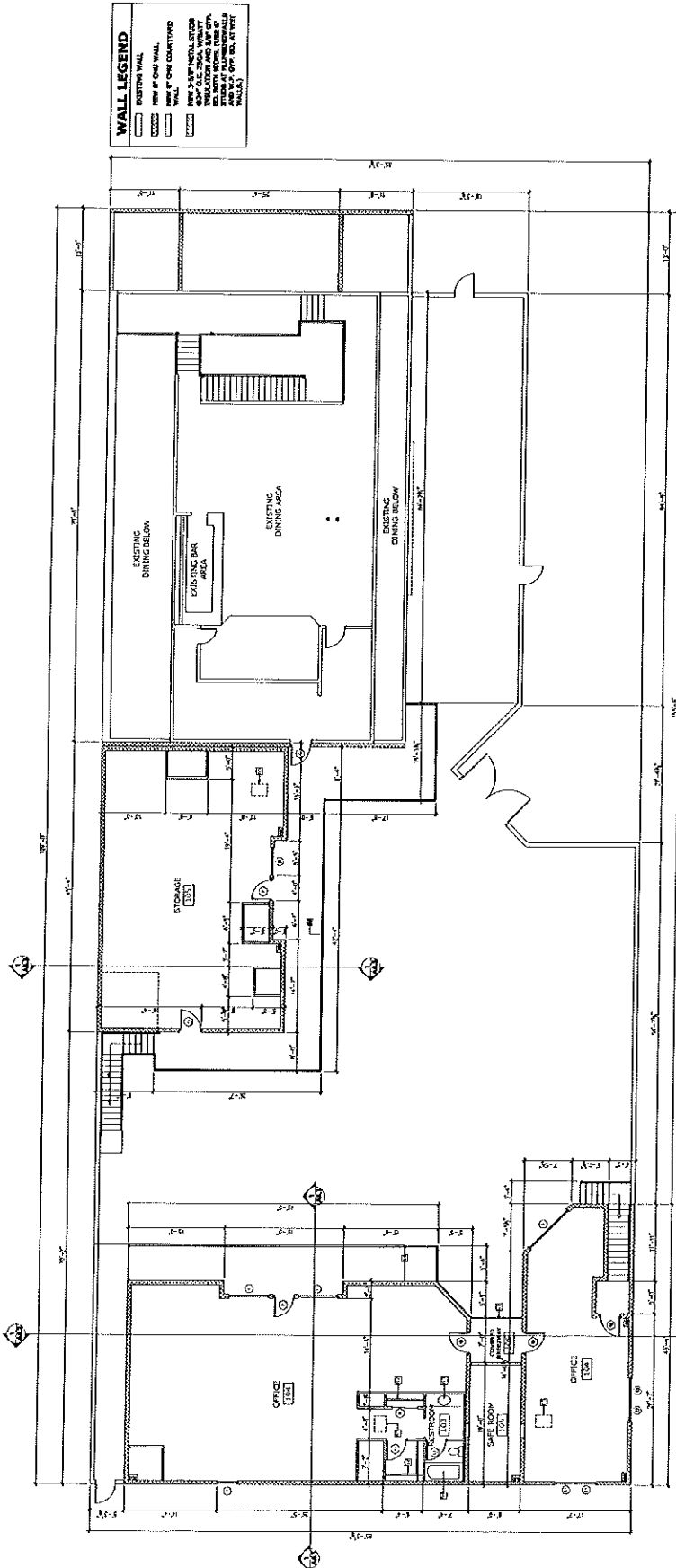

WALL LEGEND

- EXISTING WALL
- NEW 4" CMU WALL
- NEW 8" CMU WALL
- NEW 4" CMU WALL WITH INSULATION AND VAPOR BARRIER
- NEW 8" CMU WALL WITH INSULATION AND VAPOR BARRIER
- NEW 4" CMU WALL WITH INSULATION AND VAPOR BARRIER
- NEW 8" CMU WALL WITH INSULATION AND VAPOR BARRIER

INTERIOR FINISH SCHEDULE

- 107 FLOOR: FINISH CONCRETE
- 108 CEILING: OPEN CEILING
- 109 BASE: 4" RUBBER GYPSUM BASE
- 110 WALLS: SMOOTH TEXTURE, PAINTED CTP, BD.
- 111 FLOOR: CERAMIC TILE
- 112 WALLS: SMOOTH TEXTURE, PAINTED CTP, BD.
- 113 BASE: CERAMIC TILE TO 4'-0" SURROUND
- 114 WALLS: CERAMIC TILE TO 4'-0" SURROUND
- 115 FLOOR: QUARRY TILE
- 116 CEILING: CTP, BD, PAINTED / SMOOTH WASHABLE
- 117 BASE: 4" VINYL BASE WITH DEPT. REINFORCEMENT
- 118 WALLS: SMOOTH TEXTURE, PAINTED CTP, BD.
- 119 FLOOR: CARPET
- 120 CEILING: CTP, BD, PAINTED
- 121 BASE: VINYL COVER
- 122 WALLS: SMOOTH TEXTURE, PAINTED CTP, BD.
- 123 FLOOR: SEALING CONCRETE
- 124 CEILING: CTP, BD, CEILING
- 125 WALLS: SMOOTH TEXTURE, PAINTED CTP, BD.
- 126 WALLS: CTP, BD, PAINTED

KEYED DOORS SCHEDULE

- 1 NEW 3070 S.C. DOOR W/ LATCH HARDWARE
- 2 NEW 3070 TEMP. GLASS DOOR W/ LATCH HARDWARE
- 3 NEW 6070 S.C. DOOR W/ LATCH HARDWARE
- 4 NEW 6070 S.C. DOOR W/ LATCH HARDWARE
- 5 NEW 6070 S.C. DOOR W/ LATCH HARDWARE
- 6 NEW 6070 S.C. DOOR W/ LATCH HARDWARE
- 7 NEW 6070 S.C. DOOR W/ LATCH HARDWARE
- 8 NEW 6070 S.C. DOOR W/ LATCH HARDWARE
- 9 NEW 6070 S.C. DOOR W/ LATCH HARDWARE
- 10 NEW 6070 S.C. DOOR W/ LATCH HARDWARE
- 11 NEW 6070 S.C. DOOR W/ LATCH HARDWARE
- 12 NEW 6070 S.C. DOOR W/ LATCH HARDWARE
- 13 NEW 6070 S.C. DOOR W/ LATCH HARDWARE
- 14 NEW 6070 S.C. DOOR W/ LATCH HARDWARE
- 15 NEW 6070 S.C. DOOR W/ LATCH HARDWARE
- 16 NEW 6070 S.C. DOOR W/ LATCH HARDWARE
- 17 NEW 6070 S.C. DOOR W/ LATCH HARDWARE
- 18 NEW 6070 S.C. DOOR W/ LATCH HARDWARE
- 19 NEW 6070 S.C. DOOR W/ LATCH HARDWARE
- 20 NEW 6070 S.C. DOOR W/ LATCH HARDWARE

KEYED WINDOWS SCHEDULE

- 1 4'-0" W X 6'-0" H WINDOW, TYP. TEMP. GLASS
- 2 6'-0" W X 6'-0" H WINDOW, TYP. TEMP. GLASS
- 3 8'-0" W X 6'-0" H WINDOW, TYP. TEMP. GLASS
- 4 8'-0" W X 6'-0" H WINDOW, TYP. TEMP. GLASS
- 5 8'-0" W X 6'-0" H WINDOW, TYP. TEMP. GLASS
- 6 8'-0" W X 6'-0" H WINDOW, TYP. TEMP. GLASS
- 7 8'-0" W X 6'-0" H WINDOW, TYP. TEMP. GLASS
- 8 8'-0" W X 6'-0" H WINDOW, TYP. TEMP. GLASS
- 9 8'-0" W X 6'-0" H WINDOW, TYP. TEMP. GLASS
- 10 8'-0" W X 6'-0" H WINDOW, TYP. TEMP. GLASS
- 11 8'-0" W X 6'-0" H WINDOW, TYP. TEMP. GLASS
- 12 8'-0" W X 6'-0" H WINDOW, TYP. TEMP. GLASS
- 13 8'-0" W X 6'-0" H WINDOW, TYP. TEMP. GLASS
- 14 8'-0" W X 6'-0" H WINDOW, TYP. TEMP. GLASS
- 15 8'-0" W X 6'-0" H WINDOW, TYP. TEMP. GLASS
- 16 8'-0" W X 6'-0" H WINDOW, TYP. TEMP. GLASS
- 17 8'-0" W X 6'-0" H WINDOW, TYP. TEMP. GLASS
- 18 8'-0" W X 6'-0" H WINDOW, TYP. TEMP. GLASS
- 19 8'-0" W X 6'-0" H WINDOW, TYP. TEMP. GLASS
- 20 8'-0" W X 6'-0" H WINDOW, TYP. TEMP. GLASS

2nd. FLOOR PLAN KEYED NOTES

- 1 NEW 4'-0" GUARDWALL
- 2 NEW 4'-0" GUARDWALL
- 3 NEW 4'-0" GUARDWALL
- 4 NEW 4'-0" GUARDWALL
- 5 NEW 4'-0" GUARDWALL
- 6 NEW 4'-0" GUARDWALL
- 7 NEW 4'-0" GUARDWALL
- 8 NEW 4'-0" GUARDWALL
- 9 NEW 4'-0" GUARDWALL
- 10 NEW 4'-0" GUARDWALL
- 11 NEW 4'-0" GUARDWALL
- 12 NEW 4'-0" GUARDWALL
- 13 NEW 4'-0" GUARDWALL
- 14 NEW 4'-0" GUARDWALL
- 15 NEW 4'-0" GUARDWALL
- 16 NEW 4'-0" GUARDWALL
- 17 NEW 4'-0" GUARDWALL
- 18 NEW 4'-0" GUARDWALL
- 19 NEW 4'-0" GUARDWALL
- 20 NEW 4'-0" GUARDWALL

2nd FLOOR PLAN
 SCALE: 1/8" = 1'-0"

PROPOSED RESTAURANT FOR:
THE MISSION AT MINDER BINDER
 715 S. MCCLINTOCK DR.
 TEMPE, AZ

SCALE: 3/8" = 1'-0"

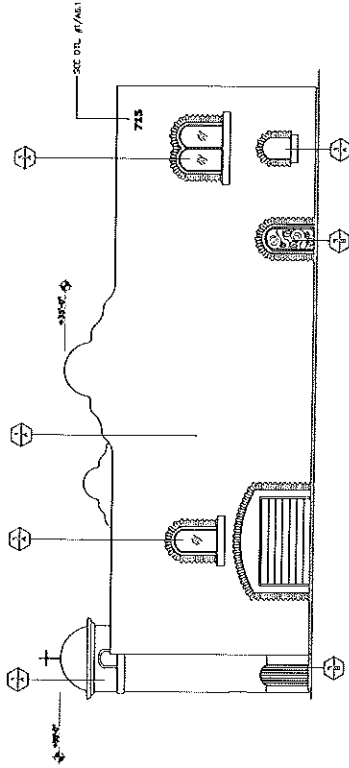

WEST ELEVATION
 3/8" = 1'-0"

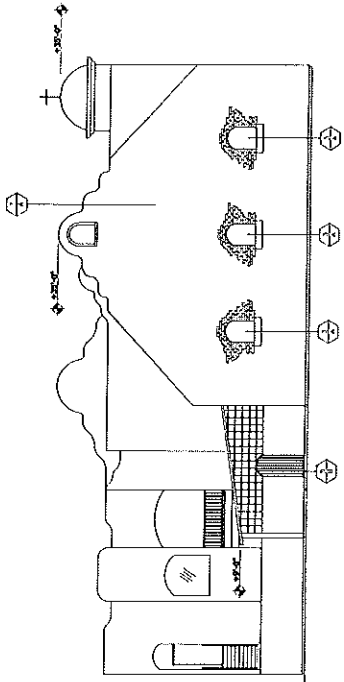

EAST ELEVATION
 3/8" = 1'-0"

MATERIAL / COLOR SCHEDULE	
SYMBOL	MATERIAL
1	STUCCO, "MEXICAN" 1 COA, STUCCO
2	FAUX STONE, "ELDORADO"
3	FAUX WINDOW
4	METAL ROOFING
5	METAL GATE
6	GUARD RAIL
7	ALUMINUM WINDOW FRAME
8	

COLOR / FINISH				
SYMBOL	COLOR NAME	NUMBER	MATERIAL	MANUFACTURER
A	TRITE WHITE	DE 6204		DUNN EDWARDS
B	CARVED WOOD	DE 6123		DUNN EDWARDS

DATE	DATE	DATE	DATE
BY	BY	BY	BY
SCALE	SCALE	SCALE	SCALE
PDC PARAMOUNT DESIGN & CONSULTING 3040 North Ariadne Ct., Mesa, Arizona 85207 T: 602-962-5608 F: 480-726-0117			
EXTERIOR ELEVATION			
DATE	AS NOTED	DATE	AS NOTED
02/19/13	02/19/13	02/19/13	02/19/13
W.Y.	H.L.	W.Y.	H.L.
SHEET NO. A3.2			TOTAL SHEETS

PROPOSED RESTAURANT FOR:
THE MISSION AT MINDER BINDER
 715 S. MCCLINTOCK DR.
 TEMPE, AZ

SCALE: 3/8" = 1'-0"

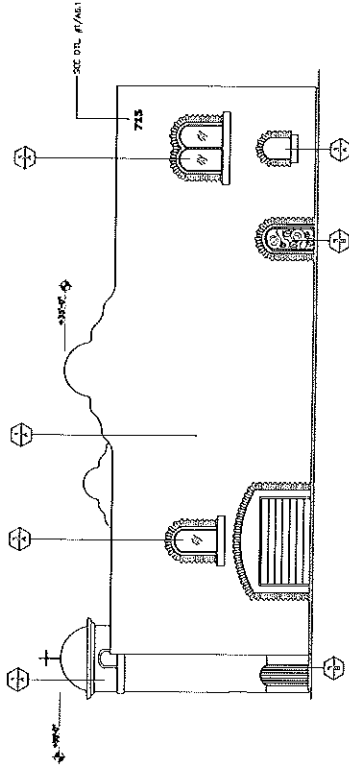

WEST ELEVATION
 3/8" = 1'-0"

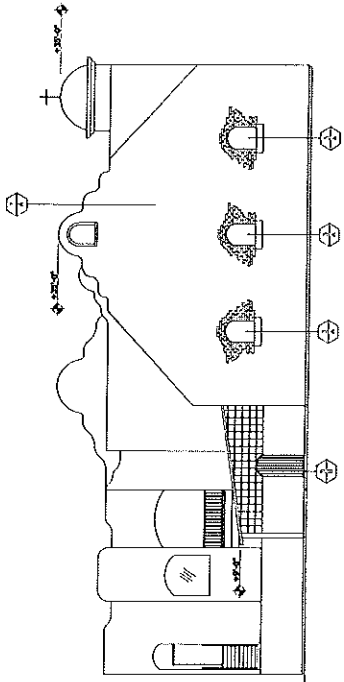

EAST ELEVATION
 3/8" = 1'-0"

MATERIAL / COLOR SCHEDULE			
SYMBOL	MATERIAL / COLOR / FINISH		
1	STUCCO, "MEXICAN" 1 COA, STUCCO		
2	FAUX STONE, "ELDORADO"		
3	FAUX WINDOW		
4	METAL ROOFING		
5	METAL GATE		
6	GUARD RAIL		
7	ALUMINUM WINDOW FRAME		
8			
COLOR / FINISH			
SYMBOL	COLOR NAME	NUMBER	MANUFACTURER
A	TRITE WHITE	DE 6204	DUNN EDWARDS
B	CARVED WOOD	DE 8123	DUNN EDWARDS

DATE: 02/19/13	SCALE: 3/8" = 1'-0"	PROJECT: A3.2
W.Y.:	H.L.:	
EXTERIOR ELEVATION		
<p>PDC PARAMOUNT DESIGN & CONSULTING 3440 North Arroyo City, Mesa, Arizona 85207 T: 602-962-5608 F: 480-726-0117</p>		
<p>ALL WORK SHALL BE IN ACCORDANCE WITH THE 2010 INTERNATIONAL BUILDING CODES AND THE 2010 INTERNATIONAL PLUMBING AND MECHANICAL CODES. THE CONTRACTOR SHALL BE RESPONSIBLE FOR OBTAINING ALL NECESSARY PERMITS AND APPROVALS FROM THE LOCAL AUTHORITIES. THE CONTRACTOR SHALL BE RESPONSIBLE FOR OBTAINING ALL NECESSARY PERMITS AND APPROVALS FROM THE LOCAL AUTHORITIES.</p>		





THE MISSION AT MINDER BINDER

715 S. McCLINTOCK DR.
TEMPE, AZ

PROJECT NAME AND ADDRESS

NO.	REVISION / ISSUE	DATE

PDC
PARAMOUNT DESIGN & CONSULTING

3949 North Arroyos Dr., Mesa, Arizona 85207
P: 480-982-1808 F: 480-978-1617



TITLE
LANDSCAPE PLAN

SCALE 1"=20'-00"	DATE 02/15/13	DRAWN BY TJM	PROJECT L-1
---------------------	------------------	-----------------	----------------

LANDSCAPE LEGEND

- ULMUS PARVIFOLIA
- EVERGREEN ELM
- 24' BOX (HITCHING)
- BOUGAINVILLEA BARBARA KARST
- BOUGAINVILLEA
- 5 GALLON
- HEBERALDE PARVIFLORA
- RED YUCCA
- 5 GALLON
- LANTANA MONTE VIDENS
- 5 GALLON
- CONYOLULIS CASORIMA
- BUSH MORNING GLORY
- 5 GALLON
- DASTURION WHEELERII
- DEER SPOON
- 5 GALLON
- AGAVE GEMINIFLORA
- TWIN FLOWERING AGAVE
- 5 GALLON
- MILIBERBERGIA EMERSLETTI, EL TORO
- 5 GALLON
- 1" FINEST BERRIS GOLD
- DECOMPOSED GRANITE
- 5 GALLON
- 2" DEPTH IN ALL LANDSCAPE AREAS

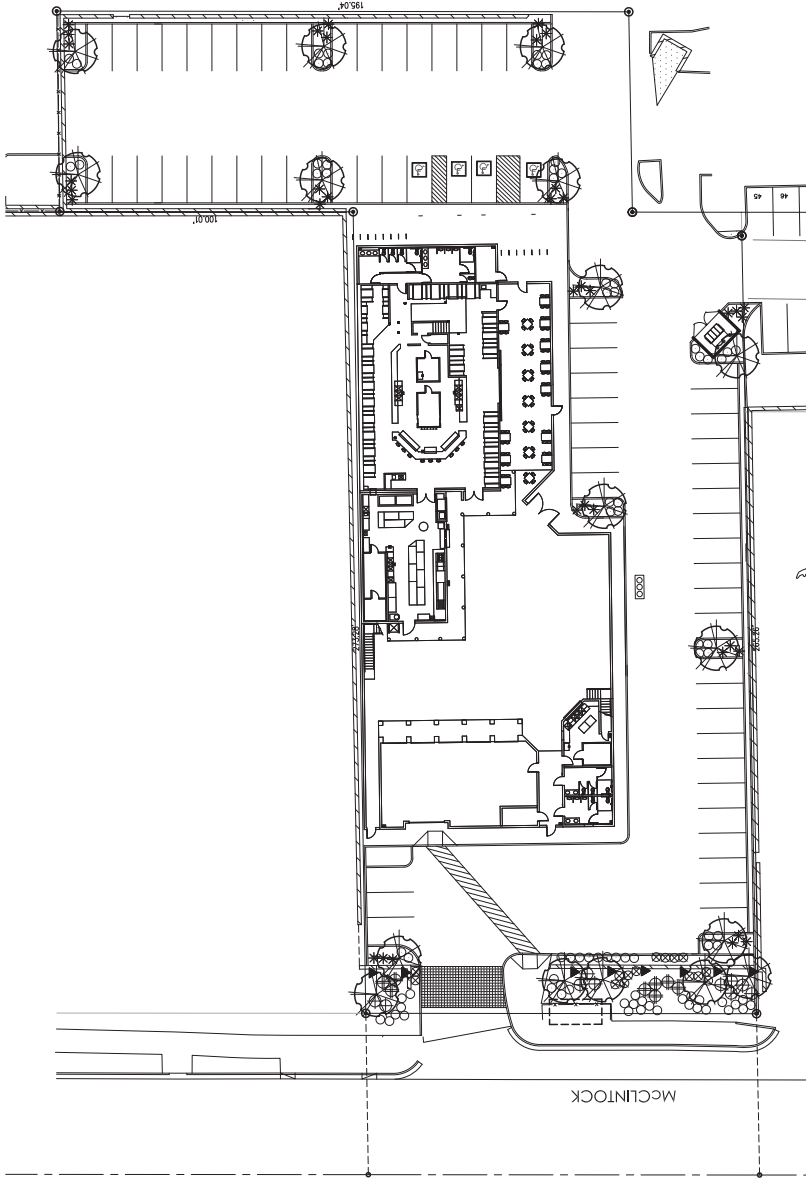

LANDSCAPE NOTES

THE ENTIRE SITE WILL BE MAINTAINED IN ACCORDANCE WITH TEMPE STANDARDS.
ALL PARKING LOT FINGERS WILL RECEIVE (1) 15 GALLON TREE AND (5) 5 GALLON SHRUBS PER SINGLE ROW OF PARKING.

ALL PLANT MATERIAL WITH IN THE CITY OF TEMPE SIGHT DISTANCE TRIANGLES ARE BE SELECTED FROM THE TEMPE APPROVED SIGHT DISTANCE TRIANGLE LIST.

ALL LANDSCAPE AREAS WILL BE TOP-DRESSED WITH A 2" DEPTH OF DECOMPOSED GRANITE.
NO RIVER ROCK PERMITTED UNLESS 2/3 OF EACH STONE IS EMBEDDED IN CONCRETE

TREES WILL BE PLACED AS TO NOT INTERFERE WITH PARKING LOT LIGHTS.
NO CLENDER HEDGES WILL BE USED IN PARKING LOT AREAS.

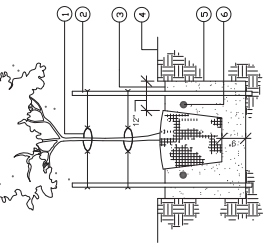
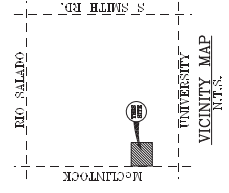

1. 1/2" RUBBER HOSE WITH #10 WIRE
2. TWO 2" ROUND BY 8' LONG GREEN TREE STAKES BURY 3" BELOW GRADE
3. 4" BUSH
4. ROUGHEN SIDES OF PLANT PIT TO PREVENT GLAZING
5. AGRIFORM TABLETS
6. BACKFILL PLANT PIT WITH SOIL MIX NOTED IN SPECS.

DOUBLE STAKING DETAIL

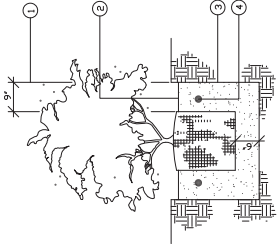

1. MINIMUM DIMENSION FOR 5 GAL. PLANTS
2. 1" BASIN
3. ROUGHEN SIDES OF PLANT PIT TO PREVENT GLAZING
4. AGRIFORM TABLETS SEE SPECS FOR RATIO
5. BACKFILL PLANT PIT WITH SOIL MIX NOTED IN SPECS.

SHRUB PLANTING DETAIL

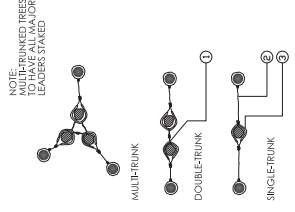

1. 5/8" CHAINING LOOP
2. EXPOSED WIRE COATED
3. 1/2" RUBBER HOSE

TREE GUYING DETAIL

LANDSCAPE PLAN
1"=20'

T.J. McQUEEN & ASSOCIATES, INC.
LANDSCAPE ARCHITECTURE
URBAN DESIGN
ARCHITECTURE
10250 N. CENTRAL EXP.
SUITE 1000
SCOTTSDALE, AZ 85258
PH: (602) 945-8337, (602) 945-8919
EMAIL: T.McQUEEN@TJMCA.NET

TJM & ASSOCIATES EXPRESSLY RESERVES ITS COMMON LAW AND OTHER RIGHTS IN THIS DESIGN. THESE PLANS ARE NOT TO BE REPRODUCED, CHANGED OR OTHERWISE USED IN ANY MANNER WITHOUT THE WRITTEN CONSENT OF T&M & ASSOCIATES.