

**CITY OF TEMPE
DEVELOPMENT REVIEW COMMISSION**

**Meeting Date: 12/09/2014
Agenda Item: 5**

ACTION: Request for a General Plan Density Map Amendment from Medium Density (up to 15 du/ac) to Medium-High Density (up to 25 du/ac), a Zoning Map Amendment from Multi-Family (R-2) to Single-Family (R1-PAD) with a Planned Area Development to establish development standards and a Development Plan Review for fifteen new two-story townhomes on .875 gross acres, for 4TH STREET WEST, located at 1301 West Fourth Street. The applicant is Tom Gosciski, TPG Holdings.

FISCAL IMPACT: While this ordinance change does not directly impact revenue, the planned development will result in collection of the standard development fees, calculated according to the approved fee structure at the time of permit issuance.

RECOMMENDATION: Staff – Approval, subject to conditions

BACKGROUND INFORMATION: 4th STREET WEST (PL140205) is located in the Sunset Neighborhood Association, west of downtown Tempe, south of the Salt River Channel. The property has been used as multi-family duplexes since 1962. The request includes the following:

- GEP14005 General Plan Density Map Amendment from Medium Density (up to 15 du/ac) to Medium-High Density (up to 25 du/ac)
- ZON14010 Zoning Map Amendment from Multi-Family (R-2) to Single-Family (R1-PAD)
- PAD14016 Planned Area Development Overlay for fifteen new two-story townhomes with development standards for building heights, setbacks, lot coverage and landscape area.
- DPR14217 Development Plan Review including site plan, building elevations, and landscape plan

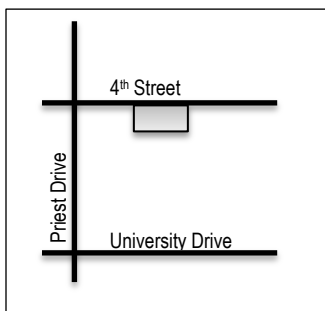

Existing Property Owner	TPG Holdings
Applicant	Tom Gosciski, TPG Holdings
Current /Proposed Zoning	R-2 Multi-Family / R1-PAD Single-Family
Gross/Net Lot Size	.875 Gross (including 1/2 of alley) / .811 Net acres
Density / # of units	18 dwelling units per gross acre / 15 units
Unit Mix	6 two-bedroom, 9 three-bedroom
Unit Size	1,383 s.f., 1,739 s.f., & 1,827 s.f.
Lot Building Area	15,148 s.f.
Lot Coverage	43% (45% maximum allowed in R-2)
Building Height	30 ft (30 ft maximum allowed in R-2)
Development Setbacks	11' front (north on 4th Street), 5'6" west side, 19' east side, 3' rear (south on alley) (20' front, 10' side, 15' rear min. R-2)
Individual Lot Setbacks	0-7' front (north, facing 4th Street), 0-5' west side, 0-5' east side, 0-3' rear (south, along alley) – depending on building orientation and adjoining walls between attached units.
Landscape area	36% (30% minimum required in R-2)
Vehicle Parking	33 spaces (30 min. req. in single-family, 33 req. in R-2)
Bicycle Parking	4 guest bike spaces, plus storage in garages

ATTACHMENTS: Ordinance, Development Project File

STAFF CONTACT(S): Diana Kaminski, Senior Planner (480) 858-2391

Department Director: Dave Nakagawara, Community Development Director

Legal review by: N/A

Prepared by: Diana Kaminski, Senior Planner

COMMENTS:

This site is located on the south side of 4th Street, east of Priest Drive, north of University Drive, and west of Beck Avenue, within the Sunset Neighborhood Association. The property has been used as a multi-family rental property since 1962, and is being proposed for redevelopment into a fifteen-unit two-story townhome development in northwest Tempe.

The applicant developed the townhome project on 5th Street, directly south of this lot in 2007. A comparison of the prior approved project to the south is included in the PAD chart within this report. To the north of the site is R-3 zoned property, with a density of 20 dwelling units per acre, and a General Plan Density Map. The applicant originally proposed 18 units for this site and reduced the project to 15 units to meet the General Plan density designation of 15 dwelling units per acre (du/ac). Density is calculated based on the gross lot area prior to right of way dedications. In this case, there were no dedication requirements within this established subdivision block. Even with the allowance of ½ of the alley in the lot area calculation, the site remained less than an acre; as a result, the proposed project exceeded the General Plan Density and would only be allowed 13 units. The applicant is requesting a General Plan Amendment to the Density Map, to increase the density from 15 du/ac to 18 du/ac in order to accommodate 15 units on the site. The next density designation within the General Plan is "up to 25 du/ac" medium-high density. The site is zoned R-2 Multi-family, but the applicant is requesting to change this to R1-PAD to allow attached single-family for sale product on individual townhome lots. The Planned Area Development would define and limit the density specific to the site plan proposed, to prevent future speculative sale of the property for an increased density. This request includes the following:

1. General Plan Density Map Amendment from Medium Density (up to 15 du/ac) to Medium-High Density (up to 25 du/ac)
2. Zoning Map Amendment from Multi-Family (R-2) to Single-Family (R1-PAD)
3. Planned Area Development to establish development standards for building height, setbacks, landscape area, building area and parking.
4. Development Plan Review of site plan, landscape plan and elevations for 15 two-story townhomes on .81 net acres.

The applicant is requesting the Development Review Commission take action on item four listed above and provide recommendations to City Council for items one through three listed above. For further processing, the applicant will need approval for a Subdivision Plat, to combine the three lots and subdivide them into 15 for-sale townhome lots with common landscape and access tracts.

PRELIMINARY SITE PLAN REVIEW

The project was submitted for Preliminary Site Plan Review in June, 2014. The project consisted of 18 units: eight units along the street front, in four units of two, and an additional ten units along the alley in one long building. The project exceeded the General Plan density and the layout was very tight; it did not provide sufficient fire access, parking, retention or open space. The applicant submitted a formal submittal in September, 2014 with a revised plan showing 15 units, to meet parking, retention and circulation requirements. The layout of the site changed to create a more dynamic building orientation with more opportunities to build community. Fire, Engineering, Traffic and other technical staff reviewing the plans determined the project was in conceptual conformance with the respective codes and was ready to proceed with the public process.

PUBLIC INPUT

- Neighborhood meeting was required
- Neighborhood meeting held: October 29, 2014 at 6:30pm at the Tempe West Side Multi-Generational Center at 817 W 5th Street.
- See attached summary of meeting provided by the applicant.
- Community Development staff attended the meeting.

Many of the attendees were residents of the development directly south of the site, owners who purchased their units from the same developer of this proposed development. The representative Sunset Riverside co-chairs were also present, and familiar with the work of the applicant. Concerns were expressed regarding lighting along the alley, that it was currently dark, but that too much light would be a problem to residents on the south side of the alley. Concerns were expressed regarding the two parking spaces on the alley, and how guest parking would be controlled, and not used by non-guests seeking a free parking space. Overall opinion of those present was supportive of the redevelopment of the site, supportive of the two-story product and design proposed, and support for the development to be built.

PROJECT ANALYSIS

GENERAL PLAN

The 1967 General Plan (projected land use through 1985) designated this area as up to 20 dwelling units per acre (du/ac). Subsequent General Plans changed the density from 9 du/ac to “up to 15 du/ac” in the 2003 General Plan (projected land use through 2030), which carried over in the new General Plan 2040 without change. The history of density designations is provided in the History and Facts section of this report. The properties on the north side of 4th street are designated Medium-High Density, allowing up to 25 dwelling units per acre (du/ac). The south side of 4th Street and the north side of 5th Street are designated as Medium Density, allowing up to 15 du/ac. This was intended as a transition down to the Low to Moderate Density designation (up to 9 du/ac) of the single-family residences established on the south side of 5th Street. The proposed development would increase the density by 20% allowing 18 du/ac, for a total of 15 residences on the property. Across 4th Street, this area allows up to 25 du/ac. Although the area is largely a multi-family area, there are condominium conversions and a few new single family products in the neighborhood. For comparison, below are some existing entitlements of similar lot size:

1200 W University – Meridian Corner	R1-PAD	19 du/ac	42 units	2.24 acres
206 S Westfall – Dolce Vida	R1-PAD	27 du/ac	37 units	1.37 acres
330 S Beck – Lake Point Village	R-3	24 du/ac	56 units	2.3 acres
1245 W 1 st St - Rio Salado Villas	R-3	29 du/ac	36 units	1.84 acres
1081 W 1 st St – Salado Grande	R-3	20 du/ac	18 units	.91 acres
501 West First	MU-3PAD	20 du/ac	7 units	0.33 acres
5th Street Lofts	R1-PAD	21 du/ac	7 units	0.33 acres
675 South	R-4PAD	25 du/ac	12 units	0.49 acres
425 W Wilson St – Clarendon Townhomes	R1-PAD	31 du/ac	24 units	0.77 acres

The applicant has provided a letter of explanation supporting the request. Staff analysis of the proposed increase in density, to allow 2 additional units, is outlined in terms of the criteria for amendments to the General Plan.

Section 6-303 D. Approval criteria for General Plan amendment (*in italics*):

1. *Appropriate short and long term public benefits* include the revitalization of an area that has experienced no significant change since 1962, and the 1967 General Plan established the density at 20 dwelling units per acre in anticipation of greater density within this area. The orientation of the units provides more natural surveillance of the area for increased safety along both the street front and the rear alley. The project fosters a sense of community in the orientation of the buildings, and provides connectivity to the existing townhome community to the south, encouraging a larger interaction between residents. The site is walking distance to a Scales School and Jaycee Park, which may attract young families.
2. *Mitigates impacts on land use, water infrastructure or transportation* the proposed project does not exceed existing water infrastructure capacity and is within the projected transportation demand for this area. The small scale of the project with 15 units is not significant enough to impact land use in the area.
3. *Helps the city attain applicable objectives of the General Plan* by introducing owner-occupied product on 4th Street to provide more diversity of housing opportunities in an area that has been predominantly rental for more than fifty years. The scale of the development fits into the surrounding architectural scale, and promotes compact efficient infill development with a livable product that exceeds available housing sizes in the area. The contemporary style rather continues the image established by the development to the south, which was built seven years ago. The design encourages pedestrian connectivity and responds to climate with the trees shading the site. The project is the first change to the area north of 5th Street, which may trigger a revitalization of the surrounding properties. The site is located adjacent to two Growth Areas: Rio Salado and the Rail Corridor, both anticipating areas of increased employment, and demand for housing close to downtown Tempe. The site has access to the Orbit, is biking

distance from the Tempe Town Lake and Light Rail, and provides easy access to the airport for residents who travel frequently.

4. *Provides rights-of-way, transit facilities, open space, recreational amenities or public art* – the proposed project is an infill project that does not require additional rights of way, but is an open site plan, not a gated community. The site does not provide transit facilities but does provide bike parking. The open space is shared in common on site, and is open and visible from the public right of way, not hidden behind walls. The site provides passive recreational opportunities, but does not provide public art.
5. *Potentially negative influences are mitigated and deemed acceptable by the City Council* by allowing the development to have two additional residential units, increasing the density from 15 to 18 dwelling units per acre was not deemed significant to have negative impacts on the surrounding area. The neighborhood meeting demonstrated support from residents of the immediate area. The alley adjacent to the property will be improved to retain stormwater run-off and function as the driveway for the residents, connecting to Priest Drive as a fully improved alley. Lighting along the garages on the south face will provide additional alley lighting, increasing safety and the ability for natural surveillance of the alley.
6. *Judgment of the appropriateness of the amendment with regard to market demands, and impacts on surrounding area, service, fiscal, traffic, historic properties, utilities and public facilities.* The proposed project is meeting an increased demand for owner-occupied housing near the downtown, as demonstrated by significant increases in requests for townhome developments near employment centers. The addition of two more residences on this site is considered appropriate to the area, and in keeping with the character of the area in a two-story form. Although the existing multi-family residences meet historic designation status by age, they are not considered contributing forms to the historic integrity of the area. The existing utilities are sufficient to meet the proposed project demands. Any impacts of utility or infrastructure requirements, such as electrical, water, sewer or alley improvements will be paid for by the development and are not a cost to the City. Existing public schools, parks and transit will serve the site sufficiently and not be impacted by the increased density.

ZONING

The proposed development would remove the property from the Multi-Family District and designate the site as a Single-Family District with a Planned Overlay District to establish the development standards. The change from R-2 Zoning to R1-PAD zoning is within the projected General Plan Residential Land Use, but provides an ownership opportunity by creating individual for sale lots with commonly maintained landscape and amenity space. Multi-family districts allow apartments, condominiums and townhome building products; single-family districts allow townhomes and detached traditional house products, requiring a subdivision plat and separate utilities to each unit. This requires more investment in infrastructure and a different quality of building to be maintained as fee-simple. The R1-PAD zoning district allows for creative design solutions on infill lots that require special development standards. The site would currently accommodate 9 units by current zoning and 13 units by current General Plan density. The allowed R-2 standards would allow up to 30' building height with setbacks of 10' side, 15' rear and 20' front yards. The proposed design creates 5.5'-19' side yard, 3' rear yard adjacent to the alley and 11' front yard setbacks. The 15 two-story units would be 30' in height. The lot coverage would decrease by 2.2% and the landscape area would increase by 6.5%. Although proposed as a single family product, the parking standards of multi-family were applied, to assure on-site guest parking. The site also has access to on-street parking on Fourth Street. The product type will fit contextually with existing multi-family developments within the area.

Section 6-304 C.2. Approval criteria for Zoning amendment (*in italics*):

1. *The proposed zoning amendment is in the public interest* because it changes a site within a predominantly multi-family rental area to enable more owner-occupied product within the area. The increased density and street and alley loaded design activates both sides of the lot for increased security surveillance of the area. By providing commonly maintained landscape along the perimeter the HOA significantly enhances the aesthetic environment of the neighborhood.
2. *The proposed zoning amendment conforms with and facilitates implementation of the General Plan Land Use*

chapter by encouraging redevelopment of underutilized properties and providing appropriate infill in character with the neighborhood. The public outreach for this project resulted in a positive response to the project.

PLANNED AREA DEVELOPMENT

The majority of owner opportunities in the immediate area have been apartments converted to condominiums, products retrofitted and subdivided for sale of airspace within the buildings. There are not many townhomes within the immediate area, the closest being the development to the south of the site, 5th Street West, which is used for comparative purposes in the development standard chart.

4th STREET WEST - DEVELOPMENT STANDARDS			
Standard	Existing R-2	Existing R1-PAD at 5th Street West (south of this site)	Proposed R-1 PAD
Density (DU/acre)	10	15	18
Number of Units	9 units	13 units	15 units
Lot Size Gross / Net		.89 acres	38,006.42 sf (.8725 acres) / 35,326.42 net sf (.81 net acres)
Minimum Lot Area per Dwelling Unit (square feet)	3,600 sf	1,078-1,319 sf	1,276 sf
Building Height			
Building Height Maximum (feet)	30 ft	35 ft (2 and 3 story)	30 ft
Building Height Step-Back Required Adjacent to SF or MF District, [Section 4-404, Building Height Step-Back]	No	No	No
Maximum Lot Coverage (% of net site area)	45%	30%	42.8%
Minimum Landscape Area (% of net site area)	30%	30%	22.7% vegetation only 36.5% open space inclusive of walkways
Setbacks:			
Development Setbacks			
Front (north, adjacent to 4 th Street)	20 ft	12 ft (south, 5 th St)	11 ft
Side (west)	10 ft	26 ft	5.5 ft
Side (east)	10 ft	9 ft	19 ft
Rear (south, adjacent to alley)	15 ft	7 ft	3 ft
Parking setback on 4 th Street	20 ft	0 ft (alley side)	18 ft
Individual Lot Setbacks			
Front (north, adjacent to 4 th Street)			
Building	20 ft	20 ft	0-7 ft
Open Structures (e.g. porch, trellis, patio wall)	15 ft	15 ft	
Side (east and west)			
Building Walls	10 ft	10 ft	0-5 ft
Porch, Balcony, Patio Wall	5 ft	5 ft	
Common Walls	0 ft	0 ft	0 ft
Rear (south, adjacent to alley)			
Building Wall, Porch, Balcony, or Patio Wall	15 ft		0-3 ft
Common Walls	0 ft		0 ft

The property is located in a high rental occupancy area with multi-family surrounding the site. Being accessible to the Orbit has provided opportunity for residents, and guests of residents, to park in the neighborhood and utilize the free local bus to access downtown Tempe and ASU. The applicant has provided two car garages for all units, plus guest parking to meet the multi-family ratio. Three of the units have additional tandem on-site parking in their driveways, and there is on-street parking available on the south side of Fourth Street. The project exceeds required single-family parking requirements and required multi-family parking standards.

PARKING STANDARDS				
Standard	Code Ratios	Existing R1-PAD at 5th Street West (south of this site)	Proposed R-1 PAD	
Residential				<u>Parking Provided:</u>
Multi-family				3 spaces + 6 additional spaces in private drives (not counted, but available) + 8 on-street public spaces (not counted, but available)
Guest	0.2 space per unit	0.2 spaces x 13 units = 3 spaces	0.2 spaces x 15 units = 3 spaces	
2 Bedroom	2 spaces per unit	2 spaces x 5 units = 10 spaces	2 spaces x 6 units = 12 spaces	12 spaces
3 Bedroom	2.5 spaces per unit	2.5 spaces x 8 units = 20 spaces	2 spaces x 9 units = 18 spaces	18 spaces
Single-family	2 spaces per unit (30 required for 15 single family units, regardless of bedroom count)	33 required 45 on site provided	R1-PAD requirement shall be established with the PAD Overlay	33 required/provided 47 available

Section 6-305 D. Approval criteria for P.A.D.:

1. The proposed residential land use is allowable in Part 3.
2. The development standards listed above, as established as part of the PAD Overlay District will be met in the development of this site.
3. The proposed PAD is not a part of an overlay district identified in Part 5
4. The conditions of approval are reasonable to ensure conformance with the provisions of the Zoning and Development Code.

DEVELOPMENT PLAN REVIEW

Site Plan

The site has three buildings along the street front; the westernmost building is set back 15 feet from the street, with additional landscape in the right of way, creating a traditional 27' landscaped front yard with a porch facing the street from this single unit. The other two buildings on Fourth Street have the side of the end units facing the street, with the buildings extending south through the site to the alley; each building contains five units staggered, creating a "V" shape opening to the south of the site. Shifting each unit maximizes opportunities for windows as well as architectural differentiation between units. Another two buildings, each containing two units, are located along the south alley side. Guest parking spaces are tucked in on the alley side, and an additional one tucked in on the west side of the site. The property is accessed from Fourth Street by two drives, with garages backing into this area which serves as a common court between the units. Three of the larger townhomes have driveways of sufficient depth to allow tandem parking, similar to traditional single family detached products. The east side has a larger buffer than the west, due to the driveway at the eastern end of the site. Fire access is available from both street and alley side. Southern units access garages from the alley, which is required to be improved to accommodate this project. The site layout breaks up the street front massing, providing views between buildings, hiding parking, and creating a strong street presence with the units along Fourth Street. Access from the alley side is controlled by gates. The front of the site is open to connect with the community.

Building Elevations

The building elevations are contemporary rectilinear forms with flat parapet roofs. The building heights vary and the facades change in depth to add architectural interest to the simple forms. The massing and change of planes of the elevations creates interest with light and shadow on the building surfaces and materials. Windows are sized appropriate to the interior space, with large picture windows in the primary living areas, smaller windows and clerestory allow light and provide privacy on the inside, with visual variation to the exterior façade. The primary building material is a scored elastomeric stucco product painted in warm neutral tones. Other material details include horizontal cement board siding painted a dark taupe, solid core wood doors painted a light copper color, metal shade projections and wrought iron canopies painted dark warm grey and painted metal garage doors painted to blend with the adjacent building material. The first floor uses a U-Channel recess between bands of stucco, creating a deeper and wider recess than a standard score joint. This application creates a banding accentuated by lighting and shadows. The upper floors are off white and pale gold colors that lighten the massing. Low patio walls are integral colored masonry blocks, in a gold tone. The application of colors and combination of materials creates a warm approachable contemporary design.

Landscape Plan

The landscape plan incorporated four tree species onto this .8 acre site, all with a minimum tree caliper of 1 ½". The trees include Heritage Oak, Shoestring Acacia, Arizona Yellow Bells and Palo Blanco Acacia. Shrubs include Little Leaf Cordia, Firecracker Bush, Tecoma Orange Bells, Purple Hop Bush, Dwarf Katie Ruellia, Red Hesperaloe and Red Justicia. Accents include Night Blooming Cereus, Yello Bulbine, Cape Aloe, and Slipper Plant. Ground Covers include Bush Morning Glory, Blue Euphorbia, Lantana, Mexican Evening Primrose, and Guara. Turf is provided where community gathering would occur and decomposed granite is used for ground cover elsewhere. The plant palette is very diverse and large, providing a lush residential feel within the community, while maintaining low-water use plants. The street front will be significantly enhanced from the surrounding environment with street trees shading the new sidewalk and drives. The alley side provides new landscaping to shade the residences from the southern exposure and enhance the look of the property from adjacent residences. Shade is provided both from the units and the trees on site, to shade most of the walkways and a significant amount of the drive aisles. As the landscape matures, the buildings and plants will meld into a comfortably shaded community, similar to the design on fifth street, in the Fifth West development completed seven years ago.

Section 6-306 D Approval criteria for Development Plan Review

1. *Placement, form, and articulation of buildings and structures provide variety in the streetscape*; unlike most developments, which maximize the efficiency of construction by building flat rectangular boxes in uniform rows, this development breaks the mold, with a custom designed site, providing units that are oriented in several directions offering variety in street presentation as well as differentiation in units and variety in views from the units. The staggered building design of the primary two buildings is more complex in construction application, but provides greater articulation in the buildings and draws attention away from the driveway by narrowing the drive as it enters the depth of the site.
2. *Building design and orientation, together with landscape, combine to mitigate heat gain/retention while providing shade for energy conservation and human comfort*; the building orientation, building shade canopies and recesses, along with the landscape design provide shade to the public sidewalk, shade to the sidewalks within the development and shade to the units themselves, creating a comfortable intimate community with minimal heat gain from paving and building massing.
3. *Materials are of a superior quality, providing detail appropriate with their location and function while complementing the surroundings*; stucco is the primary product, with cement board used in lieu of wood for durability in the extreme desert climate. The detailing of the stucco with combinations of colors, score joints and U-channels requires a greater level of care during construction implementation. The metal canopies accent the building and add further visual interest. The proposed design exceeds the level of quality in materials and details of the surrounding existing developments from the 1960s.

4. *Buildings, structures, and landscape elements are appropriately scaled, relative to the site and surroundings; the units on Fifth Street to the south are three story townhomes, the main building type in the area are single-story duplexes and fourplexes. The buildings are broken up into five different forms and are staggered to reduce the impacts of massing. The two-story units are a transition from the three-story product to the south, and preserve the third-floor views to the residents of these existing homes.*
5. *Large building masses are sufficiently articulated so as to relieve monotony and create a sense of movement, resulting in a well-defined base and top, featuring an enhanced pedestrian experience at and near street level; the design is articulated from the low screen walls around the patios, to the recessed doorways, to the canopy overhangs and building orientation. The sense of movement is created by the use of trees in a pattern along the pathways. The variety in landscape and the bold black and gold color contrasts in the building will create a backdrop to the textures and colors of the plant pallet.*
6. *Building facades provide architectural detail and interest overall with visibility at street level (in particular, special treatment of windows, entries and walkways with particular attention to proportionality, scale, materials, rhythm, etc.) while responding to varying climatic and contextual conditions; the level of building detail, the variety of materials and colors, the change in window size and orientation, the proportion of the buildings in relation to the site, with varied setbacks, create a unique project that is responsive to the security needs of the site, the environmental considerations of the climate and the contextual relationship to existing adjacent residences.*
7. *Plans take into account pleasant and convenient access to multi-modal transportation options and support the potential for transit patronage; the site has bike parking and access to Orbit free transit, as well as easy access to the valley bus line on Priest, and is approximately 1 mile from light rail stations in two directions.*
8. *Vehicular circulation is designed to minimize conflicts with pedestrian access and circulation, and with surrounding residential uses; vehicles access units from the alley, separate from the units on the north side. Units on the north side share common drives, reducing paving, and promoting community interaction between houses. The drives could serve as exterior courtyards for community gatherings, but separate sidewalks connect to the street front and alley (via gates on the south side) to separate pedestrians from the primary vehicle access drives.*
9. *Plans appropriately integrate Crime Prevention Through Environmental Design principles such as territoriality, natural surveillance, access control, activity support, and maintenance; buildings provide windows on all four sides, with views overlooking the street and alley, increased access to the alley will provide activity support and enforcement of CC&Rs will maintain higher territoriality and landscape maintenance.*
10. *Landscape accents and provides delineation from parking, buildings, driveways and pathways; the landscape works with the buildings to create shaded patios and walkways, buffered side yards, and accented driveways.*
11. *Lighting is compatible with the proposed building(s) and adjoining buildings and uses, and does not create negative effects additional lighting in the alley will increase security, but will be designed to minimize impacts to adjacent residences.*

Conclusion

Based on the information provided and the above analysis, staff recommends approval of the requested General Plan Amendment, Zoning Amendment, Planned Area Development and Development Plan Review. This request meets the required criteria and will conform to the conditions.

REASONS FOR APPROVAL:

1. The project meets the General Plan Projected Land Use and will meet the Projected Residential Density for this site.
2. The project will meet the development standards required under the Zoning and Development Code.
3. The PAD overlay process was specifically created to allow for greater flexibility for creatively designed infill projects.
4. The proposed project meets the approval criteria for a General Plan Amendment, a Zoning Amendment, a Planned Area Development and Development Plan Review.

PAD14016

CONDITIONS OF APPROVAL:

EACH NUMBERED ITEM IS A CONDITION OF APPROVAL. THE DECISION-MAKING BODY MAY MODIFY, DELETE OR ADD TO THESE CONDITIONS.

General

1. A building permit application shall be made on or before January 29, 2017, or the zoning of the property may revert to that in place at the time of application. Any reversion is subject to a public hearing process as a zoning map amendment.
2. The property owner(s) shall sign a waiver of rights and remedies form. By signing the form, the Owner(s) voluntarily waive(s) any right to claim compensation for diminution of Property value under A.R.S. §12-1134 that may now or in the future exist, as a result of the City's approval of this Application, including any conditions, stipulations and/or modifications imposed as a condition of approval. The signed form shall be submitted to the Community Development Department no later than March 2, 2015, or the General Plan Amendment, Zoning Amendment and PAD approval shall be null and void.
3. The CC&Rs of the Homeowner's Association shall include a restriction that garages must remain accessible for parking and may not be converted to storage or livable space.
4. Permits for any work in the right of way must be obtained from the Engineering Department prior to submittal of construction documents for building permit.
5. The Planned Area Development Overlay Fourth Street West shall be put into proper engineered format with appropriate signature blanks and kept on file with the City of Tempe's Community Development Department prior to issuance of building permits.
6. An amended Subdivision Plat is required for this development and shall be recorded prior to issuance of building permits.

Site Plan

7. The site plan is approved as submitted November 25, 2014, minor modifications may be reviewed through the plan check process of construction documents; major modifications will require submittal of a Development Plan Review.
8. Provide service yard and mechanical yard walls that are at least 8'-0" tall as measured from adjacent grade and are at least the height of the equipment being enclosed, whichever is greater. Verify height of equipment and mounting base to ensure that wall height is adequate to fully screen the equipment.
9. Provide gates of steel vertical picket, steel mesh, steel panel or similar construction. Where a gate has a screen function and is completely opaque, provide vision portals for visual surveillance. Provide gates of height that match that of the adjacent enclosure walls. Review gate hardware with Building Safety and Fire staff and design gate to resolve lock and emergency ingress/egress features that may be required.
10. Provide upgraded paving at each driveway consisting of unit paving. Extend this paving in the driveway from the right-of-way line to 20'-0" on site and from curb to curb at the drive edges. From sidewalk to right-of-way line, extend concrete paving to match sidewalk.
11. Utility equipment boxes for this development shall be finished in a neutral color (subject to utility provider approval) that compliments the coloring of the buildings.
12. Place exterior, freestanding reduced pressure and double check backflow assemblies in pre-manufactured, pre-finished, lockable cages (one assembly per cage). If backflow prevention or similar device is for a 3" or greater water line, delete cage and provide a masonry or concrete screen wall following the requirements of Standard Detail T-214.

Building Elevations

13. The materials and colors are approved as presented (October 22, 2014):
 - Roof – flat with parapet – parapet shall be no taller than 30 feet, and shall fully screen rooftop equipment.
 - Second Floor - Painted Stucco – Dunn Edwards DEC724 Spanish White (buff color)
 - Second Floor - Painted Stucco – Dunn Edwards DE5296 Granola (gold color)
 - First Floor Painted Stucco – Dunn Edwards DEC721 Slopes (light brown)
 - Entrance Doors – Solid Core Wood Painted Dunn Edwards DE5300 Burmese Gold (light copper color)
 - Metal Sun Control Eyebrows – Painted Structural Steel Dunn Edwards DEA186 Black Pearl (dark cool grey color)
 - Horizontal Siding Hardy Board Cement product with 8" Lap Boards Painted Dunn Edwards DE6068 Cobblestone Path (medium cool brown or dark taupe)
 - Windows – Dual pane energy efficient with black aluminum anodized frames of varied sizes specified on plans
 - Porch Walls – 8"x4"x16" masonry screen walls integral colored buff (gold)

Provide main colors and materials with a light reflectance value of 75 percent or less. Specific colors and materials exhibited on the materials sample board are approved by planning staff. Additions or modifications may be submitted for review during building plan check process.

14. Second story windows on the south elevation of the southern buildings facing the alley, shall be designed to protect the privacy of residents of the existing properties to the south by window or glazing type.
15. Provide a fourth color variation in building paint to differentiate between attached units, no two units adjacent to each other shall appear identical: each must be identifiable as its own unit.
16. Provide secure roof access from the interior of the building. Do not expose roof access to public view.
17. Conceal roof drainage system within the interior of the building.
18. On the alley side units, provide a vision portal window either in the garage door or to the side of the door, to enable residents to view out prior to opening garage door.
19. Incorporate lighting, address signs, and incidental equipment attachments (alarm klaxons, security cameras, etc.) where exposed into the design of the building elevations. Exposed conduit, piping, or related materials is not permitted.
20. Locate the electrical service entrance section (S.E.S.) so that it is concealed from public view.

Lighting

21. Drive aisles to be illuminated to 1 foot candle, parking spaces to 2 foot candles.
22. Walkways shall be illuminated to .5 foot candles, garage doors shall be illuminated to 2 foot candles, the alley shall be illuminated to 1 foot candle as a fire lane, front doors to be illuminated to 3 foot candles.
23. Lighting design along the alley side shall include full cut-off fixtures with elliptical illumination spread to prevent light trespass onto the south side of the alley.
24. Illuminate building entrances and garage doors from dusk to dawn using a photocell controller, not a switch, to assist with visual surveillance at these locations.
25. Box lights shown on elevation key #13 shall be centered under the second story window, above the address numerals, to provide maximum visibility to the address and to architecturally subordinate the fixture from the elevation details.

Landscape

26. The plant palette is approved as proposed and specified on the landscape plan. Any additions or modifications may be submitted for review during building plan check process.

27. Irrigation notes:
 - a. Provide dedicated landscape water meter.
 - b. Provide pipe distribution system of buried rigid (polyvinylchloride), not flexible (polyethylene). Use of schedule 40 PVC mainline and class 315 PVC ½" feeder line is acceptable. Class 200 PVC feeder line may be used for sizes greater than ½". Provide details of water distribution system.
 - c. Locate valve controller in a vandal resistant housing.
 - d. Hardwire power source to controller (a receptacle connection is not allowed).
28. Include requirement to de-compact soil in planting areas on site and in public right of way and remove construction debris from planting areas prior to landscape installation.
29. Top dress planting areas with a rock or decomposed granite application. Provide rock or decomposed granite of 2" uniform thickness. Provide pre-emergence weed control application and do not underlay rock or decomposed granite application with plastic.
30. Trees shall be planted a minimum of 20'-0" from any existing or proposed public water or sewer lines. The tree planting separation requirements may be reduced from the waterline upon the installation of a linear root barrier, a minimum of 6'-0" parallel from the waterline, or around the tree. The root barrier shall be a continuous material, a minimum of 0.08" thick, installed 0'-2" above finish grade to a depth of 8'-0" below grade. Final approval subject to determination by the Public Works, Water Utilities Division.

Signage

31. The alley shall be signed for no parking in the driveways in front of the garages, and no parking in the fire lane.
32. Provide address signs on the units by the garage doors and the front doors of each unit.
 - a. Conform to the following for building address signs:
 - 1) Provide street number only, not the street name
 - 2) Composed of 4" high front door numbers and 6" high garage door numbers made of metal and individually mounted.
 - 3) With a dedicated light source.
 - 4) Coordinate address signs with trees, vines, or other landscaping, to avoid any potential visual obstruction.
 - 5) Do not affix number or letter to elevation that might be mistaken for the address.
 - b. Utility meters shall utilize a minimum 1" number height in accordance with the applicable electrical code and utility company standards.

CODE/ORDINANCE REQUIREMENTS: THE BULLETED ITEMS REFER TO EXISTING CODE OR ORDINANCES THAT PLANNING STAFF OBSERVES ARE PERTINENT TO THIS CASE. THE BULLET ITEMS ARE INCLUDED TO ALERT THE DESIGN TEAM AND ASSIST IN OBTAINING A BUILDING PERMIT AND ARE NOT AN EXHAUSTIVE LIST.

- The owner(s) shall provide a continuing care condition, covenant and restriction for all of the project's landscaping, required by Ordinance or located in any common area on site. The CC&R's shall be reviewed and placed in a form satisfactory to the Community Development Manager and City Attorney.
- Development plan approval shall be void if the development is not commenced or if an application for a building permit has not been submitted, whichever is applicable, within twelve (12) months after the approval is granted or within the time stipulated by the decision-making body. The period of approval is extended upon the time review limitations set forth for building permit applications, pursuant to Tempe Building Safety Administrative Code, Section 8-104.15. An expiration of the building permit application will result in expiration of the development plan.
- Specific requirements of the **Zoning and Development Code (ZDC)** are not listed as a condition of approval, but will

apply to any application. To avoid unnecessary review time and reduce the potential for multiple plan check submittals, become familiar with the ZDC. Access the ZDC through www.tempe.gov/zoning or purchase from Community Development.

- **SITE PLAN REVIEW:** Verify all comments by the Public Works Department, Community Development Department, and Fire Department given on the Preliminary Site Plan Review. If questions arise related to specific comments, they should be directed to the appropriate department, and any necessary modifications coordinated with all concerned parties, prior to application for building permit. Construction Documents submitted to the Building Safety Division will be reviewed by planning staff to ensure consistency with this Design Review approval prior to issuance of building permits.
- **STANDARD DETAILS:**
 - Access to Tempe Supplement to the M.A.G. Uniform Standard Details and Specifications for Public Works Construction, at this link: www.tempe.gov/index.aspx?page=2147 or purchase book from the Public Works Engineering Division.
 - Access to refuse enclosure details and all other Building Safety forms at this link: www.tempe.gov/index.aspx?page=1033. The enclosure details are under Civil Engineering & Right of Way.
- **BASIS OF BUILDING HEIGHT:** Measure height of buildings from top of curb at a point adjacent to the center of the front property line.
- **HISTORIC PRESERVATION:** State and federal laws apply to the discovery of features or artifacts during site excavation (typically, the discovery of human or associated funerary remains). Contact the Historic Preservation Officer with general questions. Where a discovery is made, contact the Arizona State Historical Museum for removal and repatriation of the items.
- **SECURITY REQUIREMENTS:**
 - Design building entrance(s) to maximize visual surveillance of vicinity. Limit height of walls or landscape materials, and design columns or corners to discourage opportunity for ambush opportunity. Maintain distances of 20'-0" or greater between a pedestrian path of travel and any hidden area to allow for increased reaction time and safety.
 - Follow the design guidelines listed under appendix A of the Zoning and Development Code. In particular, reference the CPTED principal listed under A-II Building Design Guidelines (C) as it relates to the location of pedestrian environments and places of concealment.
 - Provide method of override access for Police Department to controlled access gated common areas.
- **FIRE:** Clearly define the fire lanes. Ensure that there is at least a 20'-0" horizontal width, and a 14'-0" vertical clearance from the fire lane surface to the underside of tree canopies or overhead structures. Layout and details of fire lanes are subject to Fire Department approval.
- **ENGINEERING:**
 - Underground utilities except high-voltage transmission line unless project inserts a structure under the transmission line.
 - Coordinate site layout with Utility provider(s) to provide adequate access easement(s).
 - Clearly indicate property lines, the dimensional relation of the buildings to the property lines and the separation of the buildings from each other.
 - Verify location of any easements, or property restrictions, to ensure no conflict exists with the site layout or foundation design.
 - 100 year onsite retention required for this property, coordinate design with requirements of the Engineering Department.
- **DRIVEWAYS:**
 - Construct driveways in public right of way in conformance with Standard Detail T-320.
 - Correctly indicate clear vision triangles at both driveways on the site and landscape plans. Identify speed limits for adjacent streets at the site frontages. Begin sight triangle in driveways at point 15'-0" in back of face of curb.

Consult Intersection Sight Distance memo, available from Traffic Engineering if needed www.tempe.gov/index.aspx?page=801 . Do not locate site furnishings, screen walls or other visual obstructions over 2'-0" tall (except canopy trees are allowed) within each clear vision triangle.

- **PARKING SPACES:**
 - Distribute bike parking areas nearest to main entrance(s). Provide parking loop/rack per standard detail T-578. Provide 2'-0" by 6'-0" individual bicycle parking spaces. One loop may be used to separate two bike parking spaces. Provide clearance between bike spaces and adjacent walkway to allow bike maneuvering in and out of space without interfering with pedestrians, landscape materials or vehicles nearby.
- **LIGHTING:**
 - Design site security light in accordance with requirements of ZDC Part 4 Chapter 8 (Lighting) and ZDC Appendix E (Photometric Plan).
 - Indicate the location of all exterior light fixtures on the site, landscape and photometric plans. Avoid conflicts between lights and trees or other site features in order to maintain illumination levels for exterior lighting.
- **LANDSCAPE:**
 - Prepare an existing plant inventory for the site and adjacent street frontages. The inventory may be prepared by the Landscape Architect or a plant salvage specialist. Note original locations and species of native and "protected" trees and other plants on site. Move, preserve in place, or demolish native or "protected" trees and plants per State of Arizona Agricultural Department standards. File Notice of Intent to Clear Land with the Agricultural Department. Notice of Intent to Clear Land form is available at www.azda.gov/ESD/nativeplants.htm . Follow the link to "applications to move a native plant" to "notice of intent to clear land".
- **SIGNS:** Separate Development Plan Review process is required for signs in accordance with requirements of ZDC Part 4 Chapter 9 (Signs). Obtain sign permit for identification signs. Directional signs (if proposed) may not require a sign permit. Directional signs are subject to review by planning staff during plan check process.

HISTORY & FACTS:

1930-1960	According to Flood Control District of Maricopa County historic aerial photos, the subject site was used for agricultural purposes. The area was under the jurisdiction of Maricopa County.
1960-1969	Development of residences along Fifth and Fourth streets occurred; the subject site was developed in 1962.
1964	The property was zoned R-2 after annexation into Tempe.
1967	General Plan 1985 designated this site for up to 20 dwelling units per acre.
1972	General Plan 1990 designated this site for up to 9 dwelling units per acre.
1978	General Plan 1995 designated this site for up to 10 dwelling units per acre.
1992	General Plan 2000 designated this site for up to 20 dwelling units per acre.
1997	General Plan 2020 designated this site for up to 8 dwelling units per acre.
2003	General Plan 2030 designated this site for up to 15 dwelling units per acre.
2014	General Plan 2040 designated this site for up to 15 dwelling units per acre.

January 8, 2015 First City Council Hearing for this request.

January 29, 2015 Second City Council Hearing for this request.

ZONING AND DEVELOPMENT CODE REFERENCE:

Section 6-302, General Plan Amendment

Section 6-304, Zoning Map Amendment

Section 6-305, Planned Area Development (PAD) Overlay districts

Section 6-306, Development Plan Review



DEVELOPMENT PROJECT FILE

for

4th STREET WEST

ATTACHMENTS:

1. Location Map
2. Aerial
3. General Plan Density Map
- 4-10. Letter of Explanation
11. Planned Area Development
12. Site Plan
13. Landscape Plan
- 14-16. Floor Plans
- 17-20. Building Elevations
- 21-24. Colored Elevations
- 25-27. Building Sections
28. Site Photos
29. Neighborhood Meeting Summary

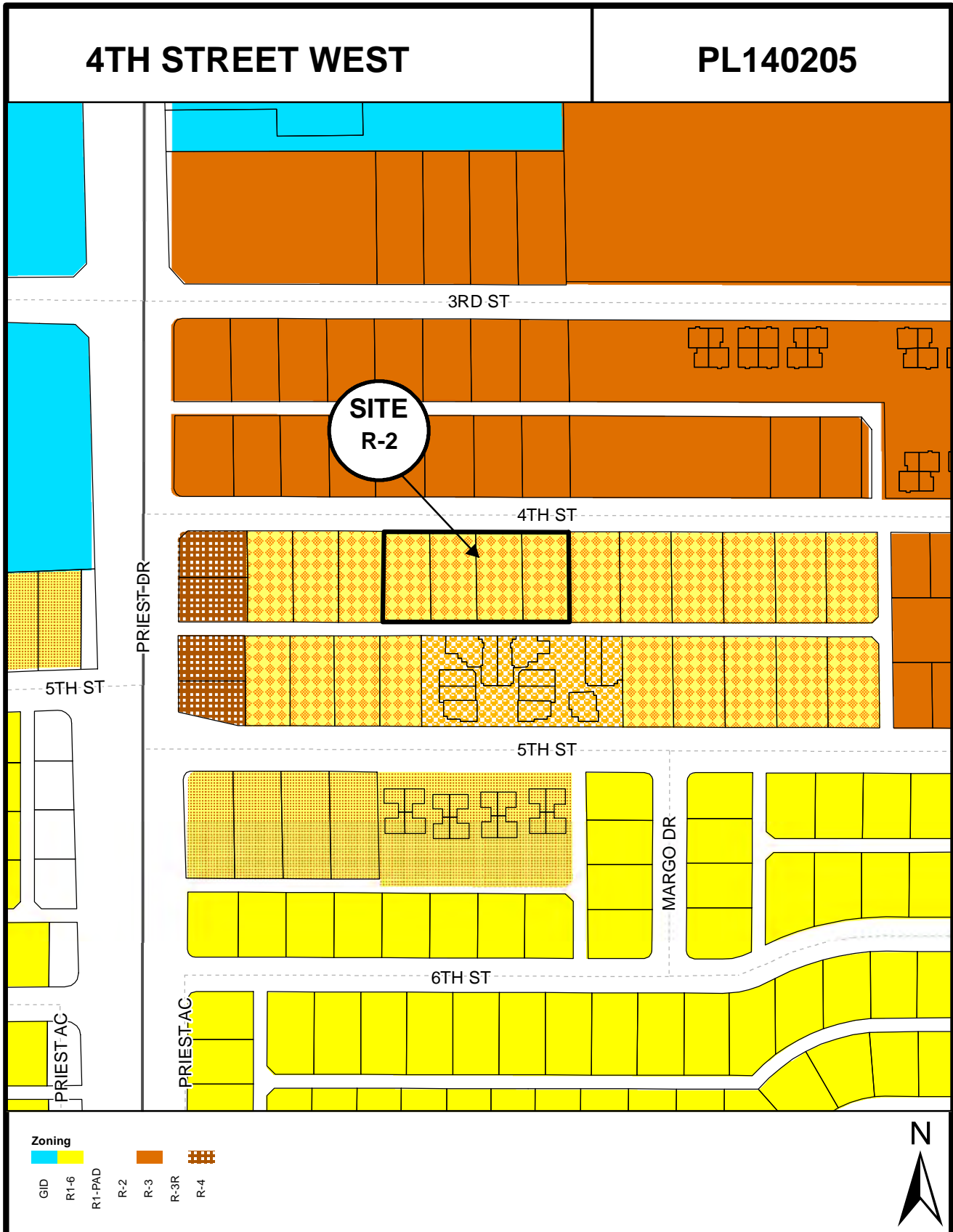

Location Map

4TH STREET WEST

PL140205

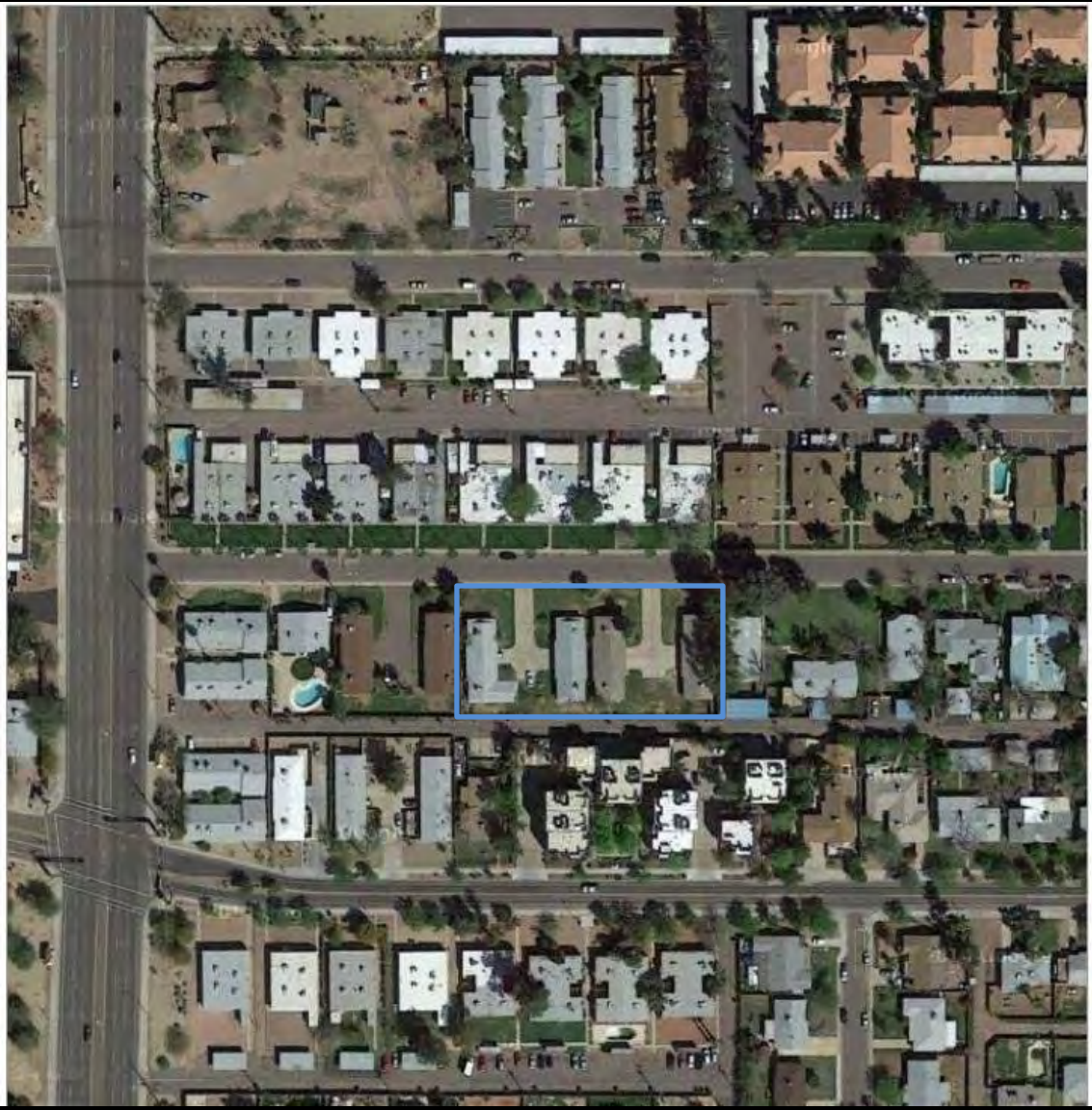

Aerial Map

LETTER OF EXPLANATION and INTENT for:

4TH STREET WEST

**A Proposed Single Family Townhouse Community
1301 West 4th Street, Tempe, Arizona 85281**

DATE: November 21, 2014

Submitted to:

City of Tempe, Planning Division
31 E. 5th Street, Tempe AZ

Submitted by:

Thomas Gosciski
TPG Holdings, LLC
8501 E. Citrus Way
Scottsdale, AZ 85250

Overview:

This is a Letter of Intent requesting the following 4 planning entitlements:

- 1.) General Plan Amendment
- 2.) Zoning Map Amendment
- 3.) Planned Area Development Overlay
- 4.) Development Plan Review

This is a proposed new housing development which will provide 15 new single family town houses on 2 existing city lots (0.875 acres). This property presently has 4 older one story apartment buildings in moderate to poor condition. Each of the two existing lots has two separate buildings that have 2 apartments. Each separate building could be classified a duplex residence. The total existing property has 4 duplex rental apartments. This proposed development, 4th Street West, will establish a pedestrian friendly community of owner occupied single family residences. This townhouse planned development is designed to specifically meet the criteria of Tempe Planning intents and also adhere and conform to the Tempe 2040 General Plan.

Existing Conditions:

Direction	2040 GP Classification	Existing Zoning	Existing Use
On site	Residential Medium Density 15 DUAC	R-2	Apartments
North	Residential Medium/High Density Up to 25 DUAC	R-3	Apartments

South	R1-PAD Medium Density Up to 20 DUAC	R1-Pad	Single Family Town Houses
East	Medium Density Up to 20 DUAC	R-2	Apartments
West	Medium Density Up to 20 DUAC	R-2	Apartments

Zoning Map Amendment justification-

This new development, 4th Street West, will adhere to the 5 guiding principles of the 2040 General plan (per page 7 of General Plan Introduction) as follows:

- 1.) Principle: Balanced Land Use-
This project will provide a high quality single family housing for the expanding needs of ASU and also for the expanding employment opportunities in the nearby locations. 4th Street West will support "balanced land use" by providing a higher quality more efficient town house product. These homes will have a friendly design with front entry porches and quality pedestrian paths that will encourage socializing and a more friendly community. This very distinctive contemporary housing type will be extremely efficient by using a smaller building footprint to provide a higher quality and more energy efficient type of residence.
- 2.) Principle: Enhanced Quality of Life and Preservation of Neighborhood Character-
This project will create conditions that will keep the neighborhood desirable, safe, attractive, and healthy with a strong sense of community. A pedestrian friendly and safe environment will be maintained without having to use a gated security system. These townhouses are specifically designed to fit in with the existing neighborhood character. The homes will be safe, attractive and healthy and will enhance the neighborhood with a strong sense of community. Open space will be specifically designed to enhance opportunities for residents and visitors to walk, relax and be more sociable.
- 3.) Principle: Increased Economic Vitality-
This project will increase the existing tax base by providing more quality homes on this land parcel. And the property values should appreciate in worth as this housing type is utilized. This prime location is well suited for this type of residential community which can only promote more sustained economic growth for this part of Tempe. Economic vitality and jobs should be stimulated as well by this higher quality and higher density type of housing.
- 4.) Principle: Sustained Mobility/ Greater Accessibility-
This project will reduce the single occupancy vehicle (SOV) trips and

encourage more support for the existing mass transit systems. Bicycling, mass transit and pedestrian modes of transportation are readily available and accessible for this project. Various bicycle parking centers are evenly distributed through this development. 4th Street West residents will have good choices for various transportation modes. The higher density will allow for more to live more closely to their employment or school destinations in Tempe.

5.) Principle: Sustainable Environmental Stewardship-

4th Street West emphasizes a quality landscape plan which utilizes shade trees, low water use xeriscape plants, and a sustainable environment that preserves resources and is beneficial to human health. The configuration of the buildings creates pockets of protected areas more suitable for quality landscape and human enjoyment. This higher density development actually embraces and provides for a better and healthier environment.

PAD Justification-

The PAD Overlay District is deemed necessary and appropriate because to achieve the necessary density the building setback requirements will have to be properly re-considered to achieve the necessary value and quality of this project. The spirit of the general development standards will be maintained and actually enhanced with the use of the PAD Overlay. The General Plan Principles will be more easily met with using a PAD Overlay. 4th Street West needs to be classified as Medium/High Density. This would be an increase in planned density from 15 DUAC to 18 DUAC. The total gross square footage of the site is 38,006.42 sf or .8725 acres.

Therefore with the 15 2-story single family residences the density will be 18 DUAC. This is an increase of 3 DUAC from the medium density requirement of 15 DUAC. This PAD request is necessary and required for the municipal approval process.

Development Plan Review Justification-

The placement of buildings reinforces and provides variety to the street wall, maximizes natural surveillance and visibility of pedestrian areas, enhances the character of the surrounding area, facilitates pedestrian access and circulation and mitigates heat gain and retention through:

- a. Shade for energy conservation and comfort as an integral part of the design. This project utilizes shade trees for human comfort as well as for the aesthetics needed for appearance along 4th Street. The residences also have integral metal wall projections to protect the exposed window glass as well as to save energy.
- b. Exterior building materials are of excellent quality and are most compatible the surroundings. Steel, masonry, elastomeric stucco, wood siding is used in artistic ways to achieve interesting shade shadow and beauty.

- c. The building masses and complementing landscape design have been planned to achieve human scale enhance the surrounding beauty. The building heights are in proportion and size to adjacent similar multi-family developments.
- d. Building masses are purposely sectioned and divided by ownership. This is achieved by the projecting or receding masses that establish individual residence identity.
- e. The buildings are designed with a distinct base, body and top to achieve proper aesthetic balance. Varying roof lines and "bas relief" projections provide shade, shadow, scale and interest.
- f. Building facades include ground level windows and artistic wrought iron detailing to create interest and identity. Windows and fenestration have been carefully placed to maximize natural surveillance and create interesting views.
- g. Special treatment of entrance doors and walkways has been enhanced with front porches designed for neighborhood sociability and better livability.
- h. All on-site utilities will be properly placed underground and out of sight.
- i. All walkways will be well lighted and clear of obstructions to provide for ease and enjoyment of access.
- j. The project is in code compliance with ADA by providing accessible routes as required and recommended.
- k. This project is well served for access to multi-modal transportation options and the support of increased mass transit patronage.
- l. The site plan has been specifically designed to minimize vehicle and pedestrian conflict. An atrium configuration pedestrian courtyard space created between building masses is a solution to ease any vehicle-pedestrian conflict.
- m. Bicycle parking is integrated into the plan to make it safe and separate from vehicular traffic. This project is properly connected to nearby municipal bike path ways.
- n. Crime prevention is deterred with lighted building entrances, limited access gates, six foot high masonry walls, and private secure outdoor spaces for children and pets.
- o. Landscape accents and textured paving will separate driveways from pedestrian walkways. The site has been specifically designed to achieve proper differentiation for purposes of proper use and enjoyment.
- p. The exterior lighting has been designed and configured for better security and for control of ambient light.

General Plan Amendment justification-

1. Appropriate short and long term public benefits.
This project provides only positive benefits for short and long term. The increased density will only make Tempe more vital and dynamic for the kind of progressive city that it is now and should continue to be in the future.
4th Street West will make a very positive impact on the immediate area which has not been significantly improved or redeveloped since it was originally developed a half century ago. This new development will bring a new spirit of residential living which will be more qualitative and compact that will enhance the neighborhood and initiate a new and better environment. The HOA format of maintenance will assure long term preservation of a higher quality of landscape. Proper maintenance of the new xeriscape plantings will be enforced and covered under the HOA jurisdictions and will not have to be reliant on City code enforcement procedures. This project should influence better future development projects in this immediate area.

2. To mitigate impacts on land use, water infrastructure or transportation:
This higher density, more efficient condensed housing will naturally allow benefits that will lessen any negative impacts to planned land use or existing infrastructure. These new residences will be significantly more energy efficient. Electricity use will reduced through better insulation, more efficient appliances, and better window glazing and framing. Water will not be wasted with the modern plumbing systems with low water use fixtures and recirculation water pumps. Open space utilizing low water use plants, will increase amounts of enjoyable open space. And for transportation considerations, no longer will we be reliant on just the single vehicle occupancy. This planned development will be well served by good and various means of transportation.
In the final analysis, the density will not be significantly increased over what is projected in the General plan. The newer housing product will be more water efficient than any of the existing 1960 era building products in the area. The existing water infrastructure not be over used and should be capable of handling this new construction.

3. Helps the City attain applicable objectives of the General plan.
This development is in accord with the 5 principles of the 2014 General Plan. Re: Land Use Goal. Under LU1, strategies #2& #5 are satisfied. This project promotes housing within the hubs and also ensures shaded streets and paths that are lighted and very suitable for bicycle circulation. Under LU6, strategies #1, #4, & #6 are addressed by promoting compact, efficient infill development that will contribute to healthy lifestyles and help make Tempe a

20-minute city. And the housing offered is reasonably affordable. This development is not deemed historically significant, but it will be the first development of its kind along the 4th Street Corridor. This project will enhance the existing area and also add new elements of proper aesthetics to make this existing neighborhood stronger and more valuable in terms of property values.

Furthermore the Housing Goal Element is addressed by providing more diverse housing types. The owner occupied town house is a condensed very efficient attached single family home which can be occupied and used in multiple ways. Each plan can be useful for various types of buyers.

Re: Growth Area Element. 4th Street West will be near growth areas and will support increased employment projected for this area. This area is targeted and specifically designed to support a planned concentration of higher density development.

As for the Cost of Development Element, this project will cover the infrastructure costs and is not anticipated to trigger any additional municipal expenses.

This development is immediately accessible to Orbit, bike and pedestrian routes and is 14 city blocks from the Light Rail stop. This is a distance that walkable in less than 20 minutes.

The project is amply served with on site parking (38 spaces that include visitor and accessible).

Re: Aviation Element. This project is very near to Sky Harbor Airport and the building design will be provided to help mitigate noise from nearby flight paths. This will be accomplished primarily with better insulation that will also increase energy efficiency and thereby increase the quality of life for future residents.

Re: Open Space Element. Using the more efficient 2 story plans, a significant amount of open space (36.4%) is created and reserved for enjoyment and a higher quality of life in this development. The configuration of the building masses along with the plantings allow for quality park-like spaces for outdoor enjoyment.

Re: Safety Element. Proper lighting and well placed gates offer safety to the residents of this project. Visibility to the grounds will add a sense security through surveillance.

Note: GP Elements not applicable to this project are: Economic Development, Conservation Element, Environmental Planning Element, Water Resources Element, Recreation Element, Public Art and Cultural Amenities Element, Public Buildings and Facilities Element, Public Services Element, and Municipal Court Element.

4. Provides rights-of-way, transit facilities, open space, recreational amenities of public art.
This project conforms to these criteria. Open space has been thoughtfully provided to maximize the increased density.

5. Any potentially negative influences have been studied and evaluated. No mitigating issues are projected with respect to this project. The higher density is justified by the increase in benefits and a higher quality of life.

6. Regarding the appropriateness of this amendment to any market demands, and impact on surrounding area, service, fiscal, traffic, historic properties, utilities and public facilities:
Market demands definitely encourage this higher density development. The increased activity generated by this project only accentuates and complements the vitality and workings of Tempe in this neighborhood. The adjacent development on 1300 5th Street is very similar and has been very successful and well received. The 5th Street town house properties have appreciated and have been in good demand for re-sale. Present owners and real estate brokers are excited about having more of this similar housing product available in the immediate neighborhood. More high quality housing will benefit the present 5th Street residents by having a well maintained quality development located directly adjacent to the shared alley. The "momentum effect" of more and better housing will only help the quality of life for everyone living in the neighborhood. The general contractor of 5th Street (Tom Gosciski, TPG Holdings) has remained active with the 5th Street HOA to insure proper and continued maintenance for the properties. This same personal concern and involvement by the builder will be repeated for the 4th Street West project. By taking personal responsibility for proper upkeep of the premises, the 4th Street West project will continue the same high standards for excellent appearance of the properties. Real estate agents have found this type of housing to be very desirable and in demand by potential buyers. It is estimated the increase in the 5th Street values was an overall positive 5% that also included the previous period of housing "downturn". With the projections of the current economy, a very positive appreciation for 4th Street West should be anticipated.

Respectfully Submitted,

Thomas Gosciski
TPG Holdings, LLC

PLANNED AREA DEVELOPMENT OVERLAY FOR 4TH STREET WEST

A PORTION OF THE SOUTHEAST QUARTER, SECTION 16, TOWNSHIP 1 NORTH, RANGE 4 EAST, GILA AND SALT RIVER BASE AND MERIDIAN,
MARICOPA COUNTY, ARIZONA

ACKNOWLEDGMENT

ON THIS _____ DAY OF _____, 20__ BE-
FORE ME, THE UNDERSIGNED, PERSONALLY APPEARED TOM GOSCISKI OWNER
WHO ACKNOWLEDGED HIMSELF TO BE THE PERSON WHOSE NAME IS
SUBSCRIBED TO THE INSTRUMENT WITHIN, AND WHO EXECUTED THE FOREGOING
INSTRUMENT FOR THE PURPOSES THEREIN CONTAINED.

ON WITNESS WHERE OF, I HEREUNTO SET MY HAND AND OFFICIAL SEAL
BY _____ NOTARY PUBLIC _____ MY SEAL EXPIRES _____

TPG HOLDINGS, AN ARIZONA LIMITED LIABILITY COMPANY
BY _____ OWNER _____ DATE _____

LEGAL DESCRIPTION

THE LAND REFERRED TO HEREIN BELOW IS SITUATED IN THE COUNTY
OF MARICOPA, STATE OF ARIZONA, AND IS DESCRIBED AS FOLLOWS
LOTS 1, 2, 3 AND 4, OF JO-ELLEN HOMES, ACCORDING TO THE PLAT
OF RECORD IN THE OFFICE OF THE COUNTY RECORDER OF MARICOPA
COUNTY, ARIZONA, RECORDED BOOK 89 OF MAPS, PAGE 4
EXCEPT 1/16 OF ALL OIL, GAS, METALS AND MINERALS AS RESERVED
TO THE STATE OF ARIZONA IN THE RECORDED PATENT TO SAID LAND,
APN 124-28-024, 124-28-025, 124-25-026, 124-28-027

APPROVAL

APPROVED BY THE MAYOR AND CITY COUNCIL OF THE CITY OF TEMPE
ON THIS _____ DAY OF _____

OWNER / DEVELOPER

TPG HOLDINGS, LLC
8501 E. CITRUS WAY
SCOTTSDALE, AZ 85250
602 918-8691
AJTDEV@COX.NET

PROJECT DATA

ZONING DISTRICT PROPOSED : R-1 PAD

DWELLING QUANTITY 15 RESIDENTIAL TOWNHOUSE UNITS
18 DU/AC

BUILDING HEIGHT 30 FEET

BUILDING LOT COVERAGE 42.8 %

SITE LANDSCAPE COVERAGE 22.7

BUILDING SETBACKS

FRONT	13.5 / (11.5 ● 2ND STORY OVERHANG)
SIDE (EAST)	21 / (23 ● 2ND STORY OVERHANG)
SIDE (WEST)	5.5 / (6.8 ● 2ND STORY OVERHANG)
REAR	5.0 / (3.0 ● 2ND STORY OVERHANG)

VEHICLE PARKING QUANTITY 44 PROVIDED

PARKING DATA (BASED ON BEDROOM COUNT) :

NOTE : 9 UNITS ARE 3 BEDROOM UNITS AND 6 UNITS ARE 2 BEDROOM UNITS

THEREFORE 9 X 2.5 = 22.5

AND 6 X 2 = 12

THEREFORE 35 MIN SPACES REQUIRED PLUS 3 VISITOR SPACES

AND THIS PROJECT PROVIDES 44 TOTAL SPACES (3 VISITOR AND 6 PRIVATE VISITOR)

BICYCLE PARKING QUANTITY: 10

SITE VICINITY MAP

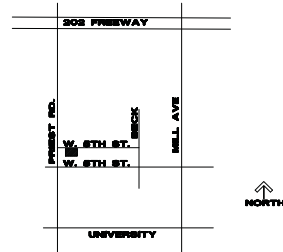

CONDITIONS OF APPROVAL: PL140205

GENERAL NOTES

DS 140521

PL 140205

REC 14044

REC 14044

PL 140205

DS 140521

4TH STREET WEST
1801 WEST FOURTH STREET, TEMPE, AZ 85281



400 S FOURTH STREET
PAINTFIELD, IA 52356
TEL: 563-885-1111
2518287210@COX.NET

DATE: 08/02/2016 4:16 PM
FILE: 140205 PL 140205

PROJECT: 140205 PL 140205
DRAWN: SAMA
CHECKED: SAMA
DATE: 8/2/16

DR
01

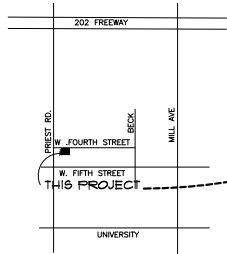

VICINITY MAP
NOT TO SCALE



EXISTING SITE AERIAL PHOTO
NOT TO SCALE

REFUSE NOTE-

LOCATIONS OF REFUSE AND RECYCLE CONTAINERS:
(Ø GAL CITY APPROVED CONTAINERS)
(ALL UNITS 9M. TO UNIT 10 SHOWN AS SHOWN)
SEE GROUND FLOOR PLAN (THIS SHEET)

- ☑ LOCATION IN GARAGE
- ☑ PER COLLECTION DAY

UTILITIES NOTE-

EACH LOT WILL BE PROVIDED
SEPARATE UTILITIES

ALL W.D.D. COMMENTS OF PG. 1
TO BE IN FINAL CHECKING COMPLIANCE
FOR MIN. PERMITS.

ADDITIONAL C.O.T. NOTES

THE ALLEY WILL BE IMPROVED TO
MEET FIRE LANE ACCESS AND WILL BE
SIGNED FOR NO PARKING OR DUMPING

ALL GATES WILL HAVE KNOX BOX
W/ KEY FOR FIRE & POLICE ACCESS.

100 YEAR RETIREMENT CALCS
WILL INCLUDE 1/2 (10 FT) OF THE ALLEY

PROJECT DATA

PROJECT DESCRIPTION: 15 TOWNHOUSE UNITS IN A PLANNED R1-PAD
MULTIFAMILY RESIDENTIAL COMMUNITY
OWNER: TPG HOLDINGS
TOM GOSCOSKI, MGR.
PROJECT NAME(S): FOURTH STREET WEST
SITE ADDRESS: 1301 W. 4TH STREET, TEMPE, AZ 85281
COUNTY PARCELS #: 124-28-024, 124-28-025, 124-28-026 & 124-28-027
ARCHITECT: SHERBORDY ART & ARCHITECTURE
DON SHERBORDY, AIA
608 S. 4TH ST FARMFIELD, IA 52556 602.246.2002

LAND SIZE: TOTAL GROSS IS 38,006 OR 8725 ACRES (THIS INCLUDES 1/2 OF THE ALLEY)
DENSITY: 18 DU/AC
BLDG. HT.: 2 STORES = 35 FT. (MAX)

TYPICAL TYPE ONE UNIT:
2 BEDROOM TWO STORY
1831 S.F., (1383 ENCLOSED)
6 TYPE ONE UNITS PROVIDED
UNITS 7, 8, 9, 10, & 11 (IN BUILDINGS A & BUILDING B)

TYPICAL TYPE TWO UNIT:
TWO STORY 3 BEDROOM
2104 S.F., (1739 ENCLOSED)
6 TYPE ONE UNITS PROVIDED
UNITS 12, 13, 14, & 15 (IN BUILDINGS A, B & E)

TYPICAL TYPE THREE UNIT:
TWO STORY 3 BEDROOM
2319 S.F., (1827 ENCLOSED)
3 TYPE ONE UNITS PROVIDED
UNITS 6, 7, & 13 (BUILDINGS C & D)

BUILDING A: FOOTPRINT AREA= 4865 S.F.
BUILDING B: FOOTPRINT AREA= 4865 S.F.
BUILDING C: FOOTPRINT AREA= 2197 S.F.
BUILDING D: FOOTPRINT AREA= 1133 S.F.
BUILDING E: FOOTPRINT AREA= 2088 S.F.

TOTAL FOOTPRINT AREA = 15,148 S.F.

LOT COVERAGE: 15,148 SF 35,410 SF = 42.8 %
OPEN SPACE: 12,882 SF 36.4 % (INCLUDES PED. WALKS & LANDSCAPE)
LANDSCAPE AREA 8,037 SF 22.7 % (ONLY PLANTING AREAS)

BLDG. SETBACKS PROVIDED: W/O OVERHANG W/ OVERHANG

13'-5" FT. FRONT	11'-5" FT. FRONT
5 FT. REAR	3 FT. REAR
7'-5"/21' SIDES	5'-5"/19' SIDES

BLDG. TYPE: 5B
SPRINKLERED: NO
BUILDING USE: RESIDENTIAL
OCCUPANCY: R-3
ALLOWABLE AREA: UNLIMITED
PARKING PROVIDED: 38 TOTAL ON-SITE SPACES FOR THE ENTIRE TOWNHOUSE DEVELOPMENT

KEY NOTES

- 1) SITE WATER RETENTION DEPRESSIONS
- 2) PEDESTRIAN WALKWAYS
- 3) GUEST PARKING
- 4) PROPOSED LOCATION OF ELEC. TRANSFORMER FOR UNDERGROUND ELEC UTILITIES
- 5) EXISTING FIRE HYDRANT(S)
- 6) BIKE RACK LOCATION, DETAIL T-500 REQUIRED.
- 7) NEW STREET LIGHT
- 8) EXISTING SEWER M.H. COVERS ARE LOCATED:
- 9) SUBDIVISION PROPERTY LINES INDICATING OWNERSHIP OF LOTS
- 10) LOCATION OF REFUSE O/ COLLECTION DAY
- 11) 2 CAR GARAGE
- 12) LANDSCAPE, OPEN USEFUL URBAN SPACE
- 13) CAR COURT
- 14) PORCH AND LOW LANDSCAPE WALLS
- 15) 30' X 30' SIGHT TRIANGLE
- 16) 0.01:1 TO 320 DRIVE DETAIL FOR 30' DRIVE
- 17) DRIVEWAY UNIT MASONRY PAVERS (20' W)

CITY OF TEMPE REVIEW : DEV.PLAN REVIEW

PROPOSED USE:
This preliminary plan places 15 semi-custom townhouse units on 0.811 acres (CURRENTLY ZONED R-2).
5 buildings of varied design will provide good choices for the home buyer market.
Two story floor plans with generous landscaping and many amenities will complement and enhance the existing area.
A modern contemporary architectural style will provide a friendly modern environment for its residents.

- A SUBMITTED BY: TOM GOSCOSKI
8501 E. CITRUS WAY
SCOTTSDALE, AZ 85250
(602) 918-8691
AID@EBOOK.NET
- B PROJECT NAME: 4TH STREET WEST
- C PROJECT ADDRESS:
1301 W. 4TH STREET (ALSO 1305, 1307, & 1309 ARE EXISTING ADDRESSES)
TEMPE, AZ 85281
PARCEL #S 124-28-024, 124-28-025, 124-28-026 & 124-28-027
- D SCALE IS 1" = 20'
AND NORTH IS INDICATED UP
- E LOCATION AND VICINITY MAPS ARE ORIENTED WITH NORTH UP
PROPERTY LINES ARE INDICATED ON PLANS
- F PERMITS AND VARIANCES:
R1-PAD ZONING IS REQUESTED
F LOCATION MAP: (SEE THIS SHEET , UPPER RIGHT HAND CORNER)
BAR SCALE AND NORTH ARROW (SEE O/ PLAN BELOW)
- G LEGAL DESCRIPTION:
LOTS #1, #2, #3 & #4 OF JO-ELEEN. A SUBDIVISION OF TRACT 36 OF STATE PLAT NO.12.
BEING PART OF THE SW 1/4 OF SECTION 16, T19N4E TEMPE, MARICOPA COUNTY, ARIZONA.
RECORDED IN BOOK 69 OF MAPS, PAGE 38.
OWNER: TPG HOLDINGS
OWNERS, TOM GOSCOSKI AND SHIRLEY A. SUMPTER
8501 E. CITRUS WAY 11114 W. FAWN LANE
SCOTTSDALE, ARIZONA AVONDALE, ARIZONA 85023
- H DIMENSIONED PROPERTY AND SET BACKS DIMENSIONED (SEE SITE PLAN)
J PARCEL SIZE: GROSS 38,006.42 SF (0.8725 AC)
(NET: 35,326 SF = HALF OF ALLEY, 2,680 SF)
- K GENERAL PLAN 2030 PROJECTED LAND USE AND DENSITY:
GENERAL PLAN USE: RESIDENTIAL
DENSITY ALLOWED: UP TO 18 DU/AC
R-2 EXISTING (R1-PAD RE-ZONING CHANGE REQUESTED)
R-3 ZONING ON THE SAME BLOCK AND
R1-PAD ZONING ON THE SAME CITY BLOCK.
- M BUILDING DATA:
6 - 2 BEDROOM, 2 STORY UNITS, ENCLOSED W/ 2 CAR GARAGE
9 - 3 BEDROOM, 2 STORY UNITS, ENCLOSED W/ 2 CAR GARAGE
LOT COVERAGE IS 15,148 SF / 35,326 (NET SF) = 42.8 %
- N BUILDING CONSTRUCTION TYPE: 5-B
O NOT FIRE SPRINKLERED, (2 HOUR RATED UNIT SEPARATION WALLS)
- P RESIDENTIAL DENSITY: 18 DU/AC
- Q PARKING DATA (BASED ON BEDROOM COUNT) :
NOTE 9 UNITS ARE 3 BEDROOM UNITS AND 6 UNITS ARE 2 BEDROOM UNITS
THEREFORE 9 X 2.5 = 22.5
AND 6 X 2 = 12
THEREFORE 35 MIN SPACES REQUIRED
AND THIS PROJECT PROVIDES 38 TOTAL SPACES
- R LANDSCAPE AREA DATA:
ON SITE: 8,037 SF (22.7 %) IN THE R.O.W.: 871 SF
- S FIRE HYDRANTS : SEE PLAN, 3 ON 4TH STREET 1 EXISTING AND 2 NEW ON THIS SITE AS NOTED.
Ø = FIRE HYDRANT SYMBOL
- T REFUSE ENCLOSURES, INDIVIDUAL RESIDENT PICK UP, (NO ENCLOSURES REQUIRED).
(SEE LOCATIONS ON PLAN RE: UNIT #3)
- U STREET & ALLEY DIMENSION, SEE SITE PLAN
- V WATER AND SEWER LINES , SEE PLAN
(SEWER ARE IN THE ALLEY EASEMENTS, SEWER M.H. LOCATED IN ALLEY.)
- W SITE WATER RETENTION:
(SEE C&D ENGR. SUBMITTAL)
- X BIKE RACKS: SEE PLAN , LOCATED NEAR MIDDLE CENTER.

COMPARISON DEVELOPMENT STANDARDS	R-2	R1-PAD
DENSITY	18	13.89
MIN LOT AREA PER DWELLING	3600 SF	3305 SF
BLDG. HT.	30 FT	30 FT
MAX. LOT COVERAGE	45%	42.8%
MIN. LANDSCAPE COV.	30%	22.7 %
SET BACKS		
FRONT	20 FT	13.5 FT/ 11.5 FT.
BLDG	20 FT	N/A
OPEN STRUCTURES	15 FT	17 FT
PARKING	20 FT	17 FT
SIDES	20 FT	17 FT
BLDG	10 FT.	5'-5"/19'
PORCH, BALCONY, PATIO WALLS	0 FT.	5 FT.
COMMON	0 FT.	N/A
REAR	15 FT.	3 FT.
BLDG WALLS, PORCH, BALCONY, PATIO WALL	0 FT.	3 FT.
COMMON WALLS	10 FT.	10 FT.
STREET SIDE	20 FT.	17 FT.
PARKING	20 FT.	17 FT.

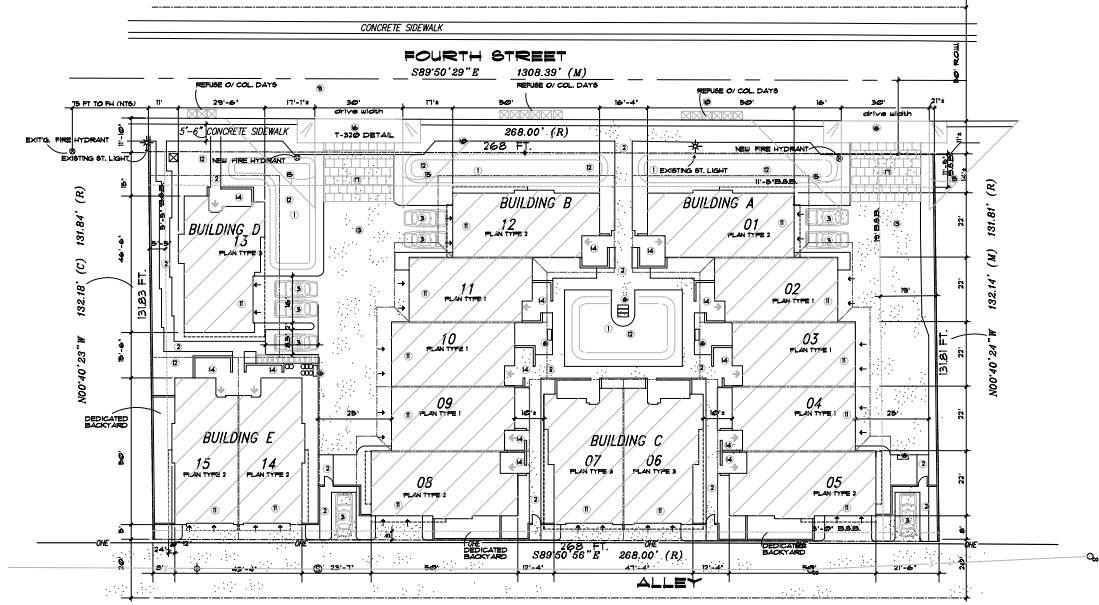

**DEV. PLAN REVIEW
ARCHITECTURAL SITE PLAN**

SCALE : 1" = 20'

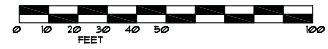

REVISIONS:

4TH STREET WEST
1301 WEST FOURTH STREET TEMPE AZ 85281

SHERBORDY ART & ARCHITECTURE
14802
5000 OWEN
SCOTTSDALE, ARIZONA 85250
TEL: 602.246.2002
2516163101@GMAIL.COM

APP. & FORNTH STREET
PARCEL# 124-28-024
TEL: 602.246.2002
2516163101@GMAIL.COM

DR
02

Preliminary Planting Plan

Project/Case: PL140205

PLANT LEGEND

NOTE: QUANTITIES SHOWN ON PLAN TAKE PRECEDENCE OVER QUANTITIES CALLED OUT IN THE PLANT LEGEND AND MAY VARY.

SYM	BOTANICAL/Common	QTY.	SIZE
TREES			
○	Quercus virginiana, v. 'fusiformis' Heritage Oak	9	24" box 1.5" minimum trunk caliper
○	Acacia stenophylla Shoestring Stenophylla	12	15 gal 1.5" minimum trunk caliper
○	Thevetia peruviana Yellow Bells - Prune(d) to tree form	19	15 gal 1.5" minimum trunk caliper
○	Acacia willardiana Palo Blanco	34	24" box 1.5" minimum trunk caliper

NOTE: All trees shall have a 1.5" minimum trunk caliper.

HEIGHT	SHRUBS	SYM	QTY.	SIZE
6'	SCP Cordia parvifolia Little-Leaf Cordia	7	5 gal	
3'	SHP Hamelia patens Firecracker Bush	27	5 gal	
8'	STP Tecoma hybrid 'Alata' Orange Bells	12	5 gal	
8'	SDO Dodonaea viscosa Purpurea Purple Hop Bush	18	5 gal	
8"	SRP Ruellia brittoniana 'Katie' Dwarf Katie Ruellia	7	1 gal	
3'	SHP Hesperaloe parviflora Red Hesperaloe	75	1 gal	
3'	SJS Justicia candidans Red Justicia	6	1 gal	

CACTUS AND SUCCULENTS

	SCS Cereus peruvianus Night Blooming Cereus	5	24" min. nt.	
1.5'	SBF Bulbine frutescens Yellow Bulbine	18	1 gal	Spaced Evenly
1'	SAV Aloe Vera Yellow Bulbine	43	1 gal	Spaced Evenly
1.5'	SAF Aloe ferox Cape Aloe	4	1 gal	
1.5'	SPM Pedilanthus macrocarpus Slipper Plant	123	1 gal	Spaced Evenly

GROUND COVERS

2'	GCC Convolvulus cneorum Bush Morning Glory	11	1 gal	36" O.C. max.
1.5'	GER Euphorbia biglandulosa Blue Euphorbia	29	1 gal	36" O.C. max.
1'	GRB Ruellia brittoniana 'Katie' Dwarf Katie Ruellia	26	1 gal	24" O.C. max.
1'	GLH Lantana Hybrid Lantana (colors yellow and purple in groups of same color)	49	1 gal	36" O.C. max.
1'	GOB Oenothera berlandieri Mexican Evening Primrose	31p	1 gal	36" O.C. max.
1.5'	GGL Guara lindheimeri Guara	32	1 gal	18" O.C. max.

DECOMPOSED GRANITE: Provide 2" minimum applied depth of 3/4" screened granite through out all planting areas, color gold, samples to be approved by Landscape Architect before delivery to job site.

All plants in public right of way shall be found on the Arizona Department of Water Resources plant list that is current at the time of approval of the Landscape Drawings.

The plantings shown on this plan are PRELIMINARY and subject to change by the Landscape Architect. Landscape Architect reserves the right to make changes in plant materials, sizes and quantities based on materials availability and the further development of the project theme and character. However, final plant material selection will be substantially the same or similar in character and theme.

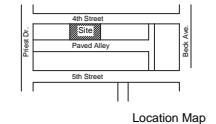
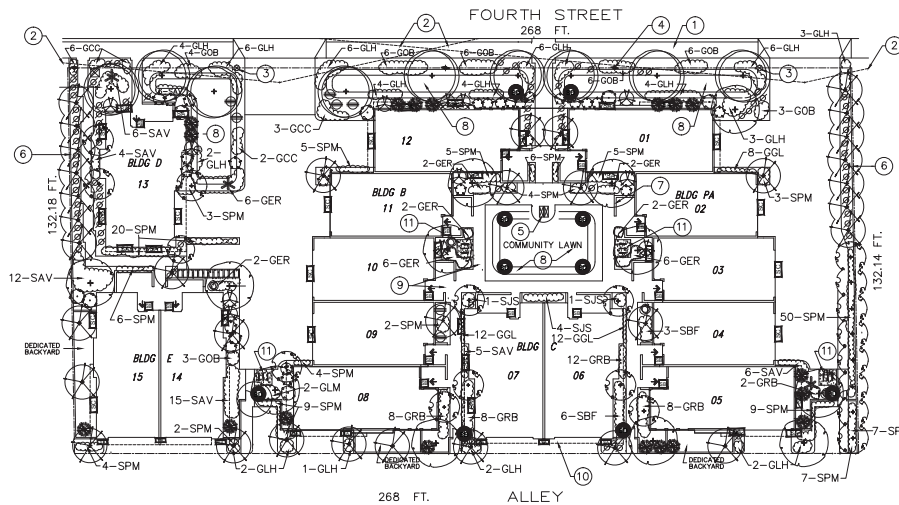

Submitted By: Landon Associates, Inc.
4148 North Arcadia Drive
Suite 200
Phoenix Arizona 85018
Phone: (602) 616-6620

Owner: TPG Holdings, LLC
8501 E. Citrus Wy.
Scottsdale, Az. 85250

Project Name: 4th Street West

Site Address: 1301 West 5th Street
Tempe, Az. 85281

Existing Zone: R-2

Zone Request: R-1 PAD

Net Site Area: 35,418 SF Net

Landscape Area: 13,003 SF = 36.7% of Net Site Area

Lawn Area: 1,003 SF = 7.7% of Landscape Area

Landscape in ROW: 918 SF

TREE REQUIREMENTS

Street frontage trees required: 9
Street frontage trees provided: 9

Parking lot island trees required: 8
Parking lot island trees provided: 9

BICYCLE PARKING

9 - 3 Bdrm DU's X 0.75 ea. = 6 spaces required
6 - 2 Bdrm DU's X 0.50 ea. = 3 spaces required
Total: 15 spaces required
Total: 16 spaces provided

PLAN NOTES:

- 1 CONC. WALK IN ROW.
- 2 SITE VISIBILITY TRIANGLE
- 3 NEW FIRE HYDRANT (TYP)
- 4 EXIST. STREET LIGHT (TYP)
- 5 EXIST. ST. LT. & ELEC. BOX TO BE RELOCATED, SEE CIVIL DWGS.
- 6 CMU PERIMETER WALL - SEE ARCH. & CIVIL DWGS
- 7 CMU LOW DECORATIVE WALL (TYP) SEE ARCH. DWGS
- 8 RETENTION BASIN - SEE CIVIL DRAWINGS
- 9 NEW CONC. WALK AND/OR PATIO (TYP) SEE ARCH. DWGS
- 10 ROOF OR SECOND FLOOR OVERHANG (TYP)
- 11 CONC. BICYCLE PARKING PAD (TYP) - (6' WIDE x 5.5' DEEP WITH 3 RACKS EACH, PROVIDE 4 PADS FOR 4 BICYCLES EA., 4 LOCATIONS

GENERAL NOTES

1. Landscape shown in "Dedicated Back Yard" areas is conceptual only and subject to unit buyer's preference.
2. Specific plant types, sizes and quantities are preliminary and subject to minor change based on market availability and minor design adjustments as project design matures. No major changes are anticipated.
3. All planting beds shall have 2" depth of 3/4" decomposed granite cover through out.
4. No material, other than ground cover, shall be placed between the street or roadway and 15' either side of a fire hydrant.
5. All ROW planting shall be compliant with current Az. Dept. of Water Resources low water use plant requirements.
6. Landscape shall be maintained by Owner. All plantings shall be on an automatic, programmable controller.
7. All trees shall be a minimum of one and one-half (1-1/2) inch caliper and shall be planted and staked in accordance with the "Standard Tree Planting Detail" as may be amended from time to time, which is on file in the office of the Development Services Department and is incorporated herein as by reference. Plant sizes shall be in accordance with the Arizona Nurseryman Association Standards.

LANDSCAPE SCHEDULE

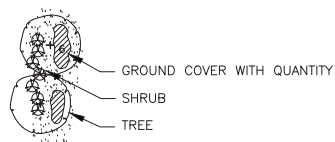

LIGHTING SCHEDULE

SHOWN FOR CONVENIENCE ONLY. SEE SEPARATE LIGHTING DESIGN BY OTHERS FOR DETAILS

Symbol	Label	Height	Description
SA	10'	WALL SCONCE	
SB	80'	WALL SCONCE	
SC	14'	FULL CUTOFF WALL MOUNT	
SD	-	FULL CUTOFF BOLLARD	
SE	12'	FULL CUTOFF AREA LIGHT	

landon associates inc.
landscape architects
land development masterplanning & design
4148 north arcadia drive suite 200 phoenix, arizona 85018
tel. 602.912.9600
fax 602.532.7462
email Valleyceor@aol.com

this document and all of its parts, inclusive of related specifications, details and other support imagery and information, is and shall remain the property of the landscape architect and shall not be copied, transferred or used for any purpose without the prior written approval of the landscape architect.

4TH STREET WEST
A new 15 Unit Townhouse Development

NO.	DATE
1	10/21/2014



DATE:	9/26/14
PROJECT:	140901.L.A.1
DRAWING:	L1.0
SHEET:	of 1

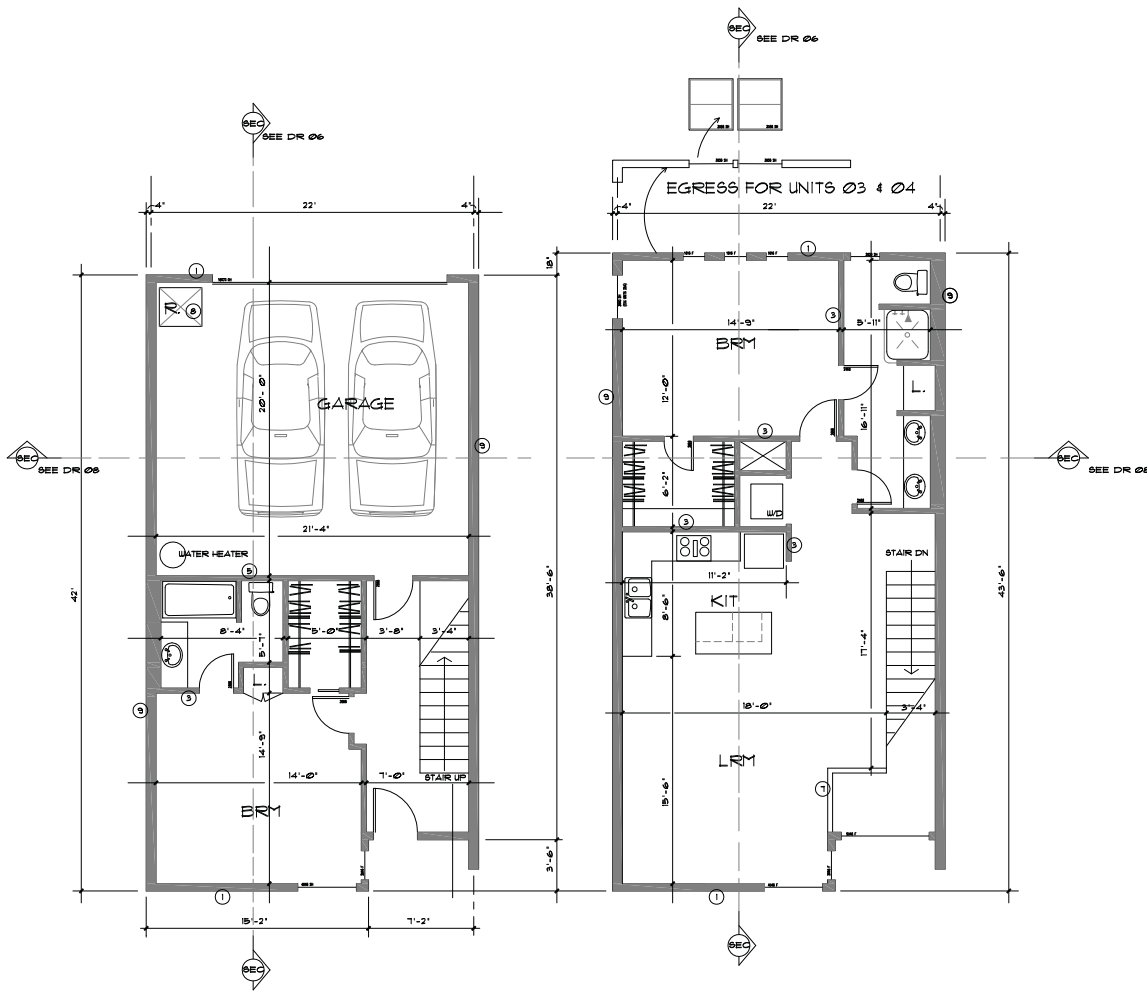

1st FLOOR

2nd FLOOR

UNITS 2-3-4-9-10-11 (2 BEDROOM) AREA 1831 SF (1383 SF ENCLOSED)
 GOSCICKI 4TH STREET

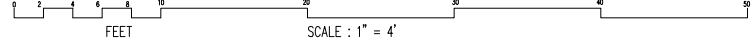

KEY NOTES	
MARK	NOTE
①	EXT. WALLS AT LIVABLE AREA- 2X4 STUDS (OR 2X6 @ 2-STORY CONDITIONS) STUDS @ 16" O.C. W/ F.G. BATTS BTUN STUDS EXT. SIDE: 3/8" OSB SHEATHING EXT. SIDE: 1" RIGID INSUL. BD. W/ LATH & 1-COAT STUCCO SYSTEM. INT. SIDE: 1/2" GYP. BOARD TOTAL R VALUE (2X4 WALL): R-11
②	EXT. WALLS AT GARAGE- 2X4 STUDS @ 16" O.C. W/ F.G. BATTS INSUL. BTUN STUDS EXT. SIDE: 3/8" OSB SHEATHING EXT. SIDE: 1" RIGID INSUL. BD. W/ LATH & 1-COAT STUCCO SYSTEM. INT. SIDE: 5/8" TYPE X GYP. BOARD TAPED
③	INTERIOR WALLS- 2X4 WALLS AT 24" O.C. W/ 1/2" GYP. BD. EA. SIDE.
④	PLUMBING WALLS- 2X4 WALLS AT 16" O.C. W/ W.P. 1/2" GYP. ON PLUMB. FIX. SIDE(S) R-11 SOUND BATTS BTUN STUDS (TYP.)
⑤	WALLS BTUN LIVABLE & NON-LIVABLE- 2X4 STUDS AT 16" O.C. W/ R-11 F.G. INSUL. BTUN STUDS 1/2" GYP. BOARD TAPED (EA. SIDE) 5/8" TYPE X GYP. BOARD TAPED (GARAGE SIDE)
⑥	INTERIOR WALLS (SOUND WALLS) 2X4 WALLS AT 16" O.C. W/ 1/2" GYP. BD. EA. SIDE. W/ R-11 SOUND BATTS
⑦	LOW WALL (GUARD RAIL)
⑧	REFUSE CONTAINER
⑨	WALL BETWEEN DUELLING UNITS 8" CMU WALL W/ SAND FILL ALL UNREINFORCED CELLS. 2 HR. FIRE RATING

REVISIONS:

4TH STREET WEST
1801 WEST FOURTH STREET TRAPE A-E 030301



SHERONDY
ART T. HERSHENDY

APP. 6 FOURTH STREET
PAINEFIELD, IN 47990
TEL: 317.862.2462 FAX: 317.862.2462
P2516281D10 030301

DR 03

PLAN TYPE

DEV. PLAN REVIEW

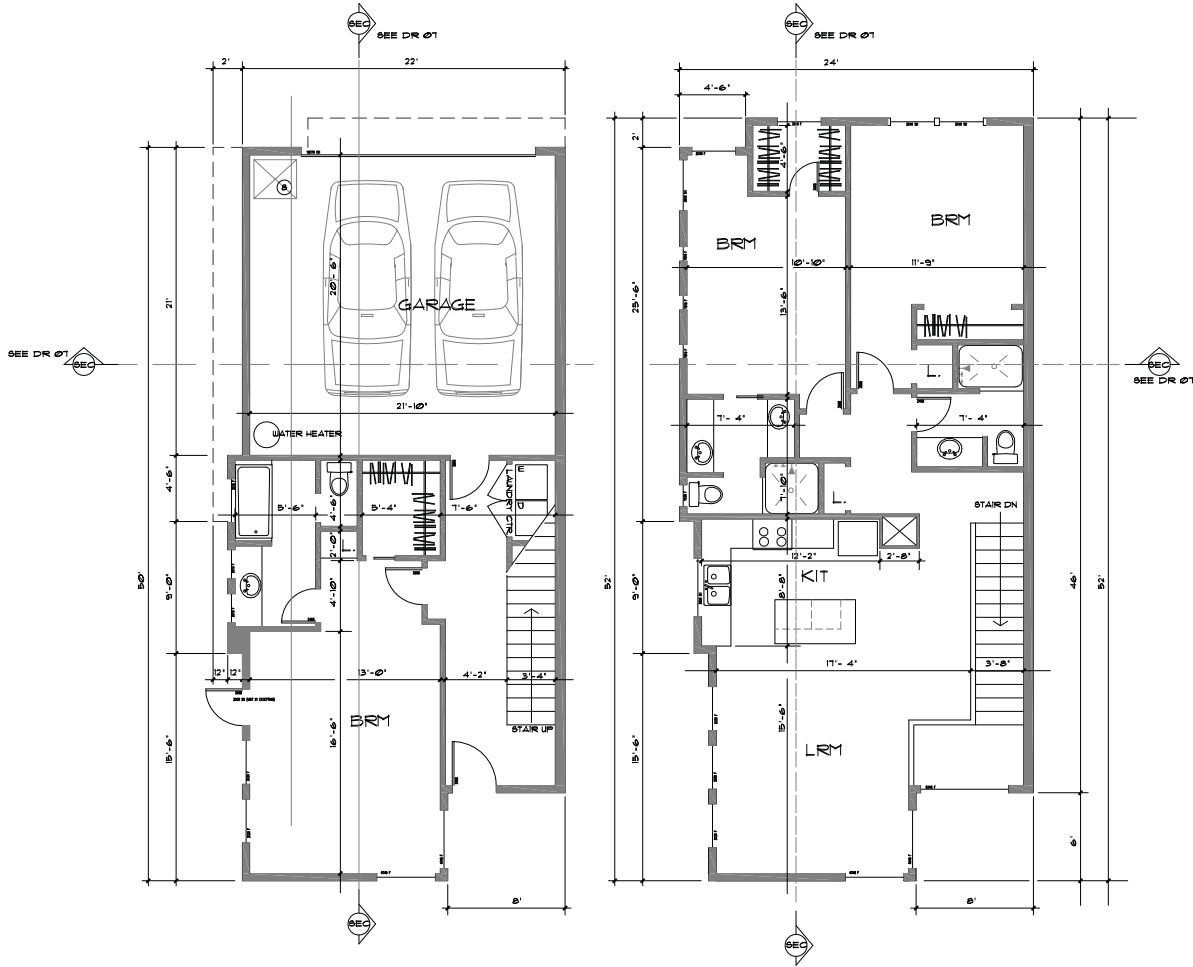

1st FLOOR

UNITS 1-12-5-8-14-15 (3 BEDROOM)
GOSCICKI 4TH STREET

2nd FLOOR

AREA 2194 SF (1739 SF ENCLOSED)

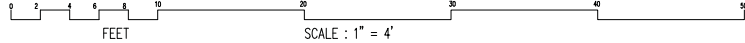

KEY NOTES	
MARK	NOTE
①	EXT. WALLS AT LIVABLE AREA- 2X4 STUDS (OR 2X6 @ 2-STORY CONDITIONS) STUDS @ 16" O.C. W/ F.G. BATTS BTJN STUDS EXT. SIDE: 3/8" OSB SHEATHING EXT. SIDE: 1" RIGID INSUL. BD. W/ LATH & 1-COAT STUCCO SYSTEM. INT. SIDE: 1/2" GYP. BOARD TOTAL R VALUE (2X4 WALL): R-11
②	EXT. WALLS AT GARAGE- 2X4 STUDS @ 16" O.C. W/ F.G. BATTS INSUL. BTJN STUDS EXT. SIDE: 3/8" OSB SHEATHING EXT. SIDE: 1" RIGID INSUL. BD. W/ LATH & 1-COAT STUCCO SYSTEM. INT. SIDE: 5/8" TYPE X GYP. BOARD TAPED
③	INTERIOR WALLS- 2X4 WALLS AT 24" O.C. W/ 1/2" GYP. BD. EA. SIDE.
④	PLUMBING WALLS- 2X4 WALLS AT 16" O.C. W/ W.P. 1/2" GYP. ON PLUMB. FIX SIDE(S) R-11 SOUND BATTS BTJN STUDS (TYP.)
⑤	WALLS BTJN LIVABLE & NON-LIVABLE- 2X4 STUDS AT 16" O.C. W/ R-11 F.G. INSUL. BTJN STUDS 1/2" GYP. BOARD TAPED (EA. SIDE) 5/8" TYPE X GYP. BOARD TAPED (GARAGE SIDE)
⑥	INTERIOR WALLS (SOUND WALLS) 2X4 WALLS AT 16" O.C. W/ 1/2" GYP. BD. EA. SIDE. W/ R-11 SOUND BATTS
⑦	LOW WALL (GUARD RAIL)
⑧	REFUSE CONTAINER
⑨	WALL BETWEEN DUELLING UNITS 8" CMU WALL W/ SAND FILL ALL UNREINFORCED CELLS. 2 HR. FIRE RATING

REVISIONS:

4TH STREET WEST
1501 WEST FOURTH STREET TRAPE AE 86381

SHERBONDY
ART T. SHERBONDY
14802
IOWA
REGISTERED PROFESSIONAL ENGINEER
404 S. FOURTH STREET
PAINFIELD IA 52996
PHONE: 319-244-0092
2016/05/10 10:02 AM
DR 04

PLAN
TYPE
2

DEV. PLAN REVIEW

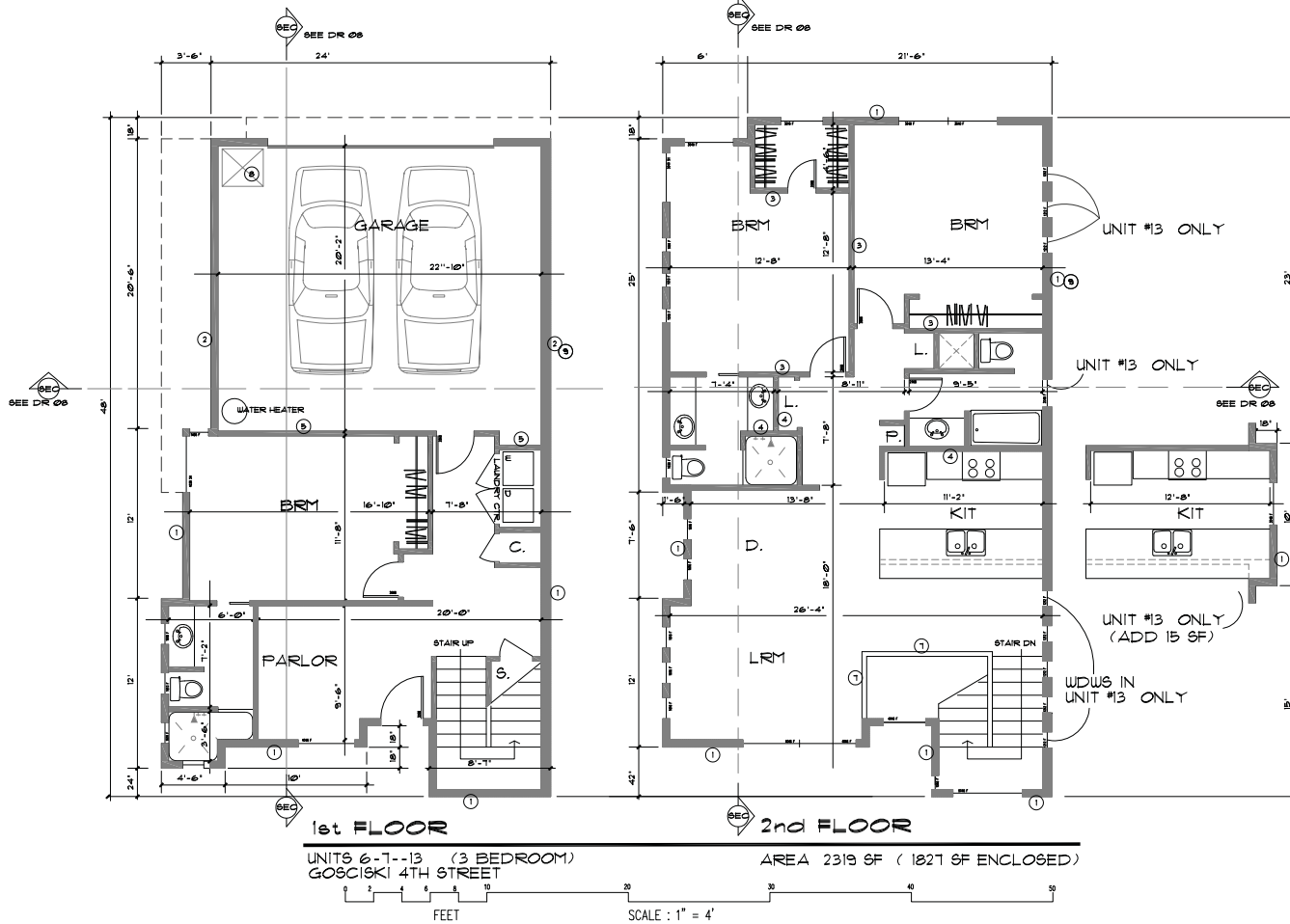

KEY NOTES	
MARK	NOTE
①	EXT. WALLS AT LIVABLE AREA- 2X4 STUDS (OR 2X6 # 2-STORY CONDITIONS) STUDS # 16" O.C. W/ F.G. BATTS BTUN STUDS EXT. SIDE: 3/8" OSB SHEATHING EXT. SIDE: 1" RIGID INSUL. BD. W/ LATH & 1-COAT STUCCO SYSTEM. INT. SIDE: 1/2" GYP. BOARD TOTAL R VALUE (2X4 WALL): R-11
②	EXT. WALLS AT GARAGE- 2X4 STUDS # 16" O.C. W/ F.G. BATTS INSUL. BTUN STUDS EXT. SIDE: 3/8" OSB SHEATHING EXT. SIDE: 1" RIGID INSUL. BD. W/ LATH & 1-COAT STUCCO SYSTEM. INT. SIDE: 5/8" TYPE X GYP. BOARD TAPED
③	INTERIOR WALLS- 2X4 WALLS AT 24" O.C. W/ 1/2" GYP. BD. EA. SIDE.
④	PLUMBING WALLS- 2X4 WALLS AT 16" O.C. W/ W.P. 1/2" GYP. ON PLUMB. FIX SIDE(S) R-11 SOUND BATTS BTUN STUDS (TYP.)
⑤	WALLS BTUN LIVABLE & NON-LIVABLE- 2X4 STUDS AT 16" O.C. W/ R-11 F.G. INSUL. BTUN STUDS 1/2" GYP. BOARD TAPED (EA. SIDE) 5/8" TYPE X GYP. BOARD TAPED (GARAGE SIDE)
⑥	INTERIOR WALLS (SOUND WALLS) 2X4 WALLS AT 16" O.C. W/ 1/2" GYP. BD. EA. SIDE. W/ R-11 SOUND BATTS
⑦	LOW WALL (GUARD RAIL)
⑧	REFUSE CONTAINER
⑨	WALL BETWEEN DUELLING UNITS 8" CMU WALL W/ SAND FILL ALL UNREINFORCED CELLS. 2 HR. FIRE RATING

REVISIONS:

4TH STREET WEST
1801 WEST FOURTH STREET TRAPE A-E 08248

REGISTERED ARCHITECT
14802
DOR OWNERS
REGULAR REG.

SHERROD
ART & ARCHITECTURE

APP. 6 FOURTH STREET
FAIRFIELD IA 52506
TEL: 563 246-2092
DESIGN@SHERRODARCHITECT.COM

DR 05



DEV. PLAN REVIEW

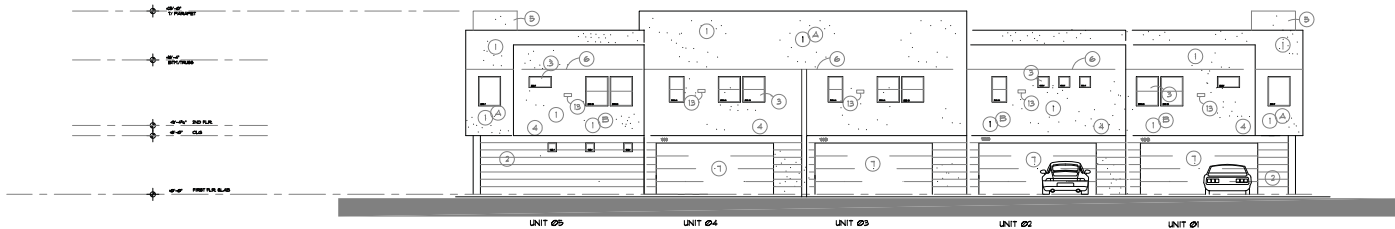

EAST ELEV BUILDING A

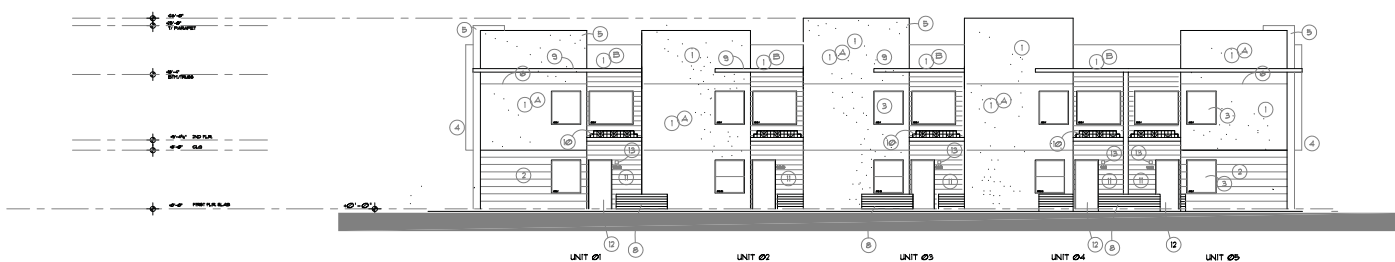

WEST ELEV BUILDING A

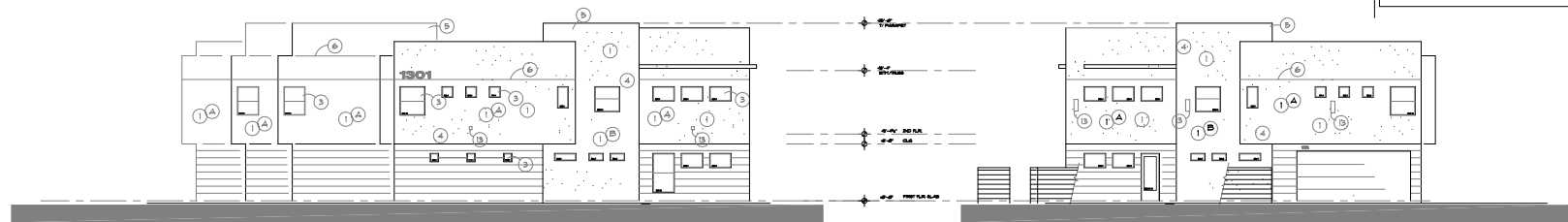

NORTH ELEV BUILDING A

SOUTH ELEV BUILDING A

KEY NOTES	
MARK	NOTE
1	ELASTOMERIC STUCCO, MAG 1 COAT. TEXTURE : SAND FINISH.
2	SCORED STUCCO, (HORIZONTAL METAL U CHANNEL) ELASTOMERIC STUCCO, MAG 1 COAT. TEXTURE : SAND FINISH.
3	WINDOW W/ SIZES INDICATED
4	CANTILEVERED (PROJECTED) EDIFICE.
5	PARAPET WALL TO SHIELD ROOF EQUIPMENT
6	STUCCO CONTROL JOINT
7	OVERHEAD 5 SECTIONAL GARAGE DOOR (PAINTED)
8	MASONRY LANDSCAPE WALLS
9	METAL EYE BROW SHADE PROJECTIONS
10	WROUGHT IRON ON THE METAL CANOPY
11	HORIZONTAL WOOD SIDING
12	ENTRANCE DOOR
	□ SC LIGHT FIXTURE □ SA LIGHT FIXTURE □ SB LIGHT FIXTURE (SEE PHOTOMETRIC PLAN AND FIXTURE CUT SHEETS)
COLOR / MATERIAL SPECIFICATION	
A	STUCCO, BUILDING BODY COLOR #1 SPEC: MAG-1 COAT R/G/B # 255/247/217 DUNN EDWARDS# DEC 724 (SPANISH WHITE) LRV: 77
B	STUCCO, BUILDING BODY COLOR #2 SPEC: MAG-1 COAT R/G/B # 255/233/165 DUNN EDWARDS# DEC 732 (ASPEN YELLOW) LRV: 70
C	STUCCO, BUILDING BODY COLOR #3 SPEC: MAG-1 COAT SCORRED @ 12" HORIZONTALLY R/G/B # 189/180/139 DUNN EDWARDS# DEC 780 TICKLED CROW LRV: 45
D	ENTRANCE DOORS SPEC: SOLID CORE WD, PAINTED R/G/B # 145/107/52 DUNN EDWARDS# DE5300 (BURMESE GOLD) LRV: 25
D	METAL SUN CONTROL EYEBROWS SPEC: PAINTED STRUCTURAL STEEL R/G/B # 27/25/22 DUNN EDWARDS# DEA 186 (BLACK PEARL) LRV: 25
D	HORIZONTAL WOOD SIDING SPEC: HARDY BD., CEMENT BD. 8" LAP. R/G/B # 123/106/83 DUNN EDWARDS# DE 6371 (BLACK JACK) LRV: 8
E	WINDOWS SPEC: DUAL PANE ENERGY EFFICIENT BLACK ALUM ANODIZED FRAMES SIZES, TYPE NOTED G/ PLANS
P	MASONRY PORCH LOW WALLS SPEC: 8X4 16 MASONRY UNITS COLOR: RGB: 253/198/90

4TH STREET WEST
 1901 WEST FOURTH STREET TRAPE AE 06049

SHERONDY
 ART T. HESTON
 14802
 NEW HAMPSHIRE
 REGISTERED PROFESSIONAL ENGINEER

APR. 6 FOURTH STREET
 FARMFIELD IA 52996
 TEL: 563 344-0092
 0216181010 060216

2022 ILL
 17-18-19
 SAA
 DR
 09

BLDG. A (AND B) EXT. ELEV.

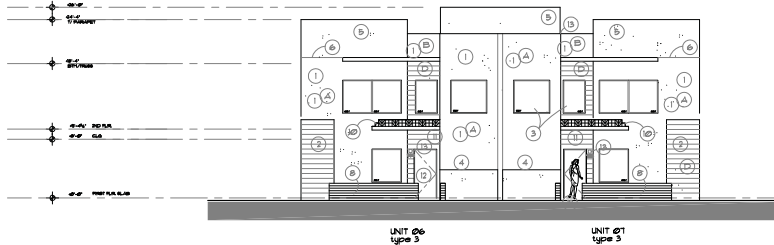

NORTH ELEV BUILDING C

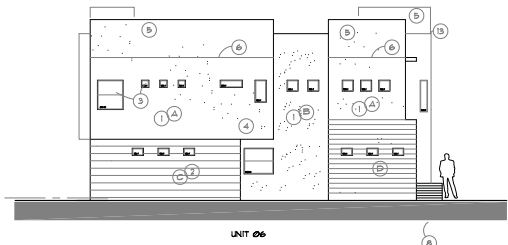

EAST ELEV BUILDING C

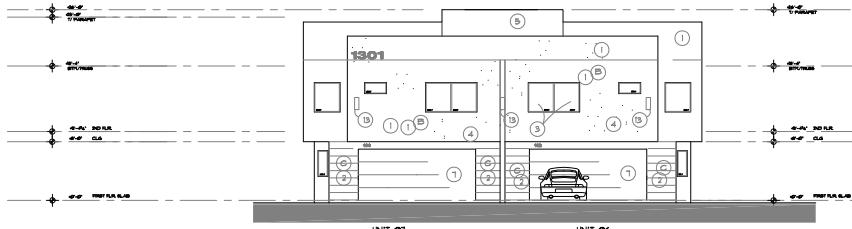

SOUTH ELEV BUILDING C

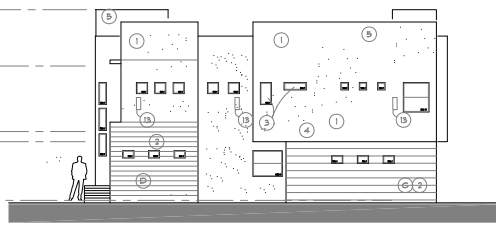

WEST ELEV BUILDING C

KEY NOTES	
MARK	NOTE
①	ELASTOMERIC STUCCO, MAG 1 COAT. TEXTURE : SAND FINISH. SCORED STUCCO. (HORIZONTAL METAL U CHANNEL) ELASTOMERIC STUCCO, MAG 1 COAT. TEXTURE : SAND FINISH.
②	WINDOW W/ SIZES INDICATED
④	CANTILEVERED (PROJECTED) EDIFICE.
⑤	PARAPET WALL TO SHIELD ROOF EQUIPMENT
⑥	STUCCO CONTROL JOINT
⑦	OVERHEAD 5 SECTIONAL GARAGE DOOR (PAINTED)
⑧	MASONRY LANDSCAPE WALLS
⑨	METAL EYE BROW SHADE PROJECTIONS
⑩	WROUGHT IRON ON THE METAL CANOPY
⑪	HORIZONTAL WOOD SIDING
⑫	ENTRANCE DOOR
⑬	<div style="display: flex; justify-content: space-around;"> □ SC LIGHT FIXTURE □ SA LIGHT FIXTURE □ SB LIGHT FIXTURE </div> (SEE PHOTOMETRIC PLAN AND FIXTURE CUT SHEETS)
COLOR / MATERIAL SPECIFICATION	
Ⓐ	STUCCO, BUILDING BODY COLOR #1 SPEC: MAG-1 COAT R/G/B # 255/247/217 DUNN EDWARDS# DEC 724 (SPANISH WHITE) LRV: 77
Ⓑ	STUCCO, BUILDING BODY COLOR #2 SPEC: MAG-1 COAT R/G/B # 255/233/165 DUNN EDWARDS# DEC 732 (ASPEN YELLOW) LRV: 70
Ⓒ	STUCCO, BUILDING BODY COLOR #3 SPEC: MAG-1 COAT SCORED @ 12" HORIZONTALLY R/G/B # 189/180/139 DUNN EDWARDS# DEC 780 (TICKLED CROW) LRV: 45
Ⓓ	ENTRANCE DOORS SPEC: SOLID CORE WD, PAINTED R/G/B # 145/107/52 DUNN EDWARDS# DES300 (BURMESE GOLD) LRV: 25
Ⓔ	METAL SUN CONTROL EYEBROWS SPEC: PAINTED STRUCTURAL STEEL R/G/B # 27/25/22 DUNN EDWARDS# DEA 186 (BLACK PEARL) LRV: 25
Ⓕ	HORIZONTAL WOOD SIDING SPEC: HARDY BD., CEMENT BD. 8" LAP. R/G/B # 123/106/83 DUNN EDWARDS# DE 6371 (BLACK JACK) LRV: 8
Ⓖ	WINDOWS SPEC: DUAL PANE ENERGY EFFICIENT BLACK ALUM ANODIZED FRAMES SIZES, TYPE NOTED O/ PLANS
Ⓗ	MASONRY PORCH LOW WALLS SPEC: 8X4 16 MASONRY UNITS COLOR: RGB: 253/198/90

4TH STREET WEST
 1301 WEST FOURTH STREET TRAPE AE 86343

SHERBONDY
 ART & ARCHITECTURE, INC.
 4TH & FOURTH STREET
 PAINEFIELD IA 52996
 TEL: 562-246-0092
 P2516261210 8202121

2022 ILL
 17-11
 SAA
 DR
 10



NORTH ELEV BUILDING D

EAST ELEV BUILDING D

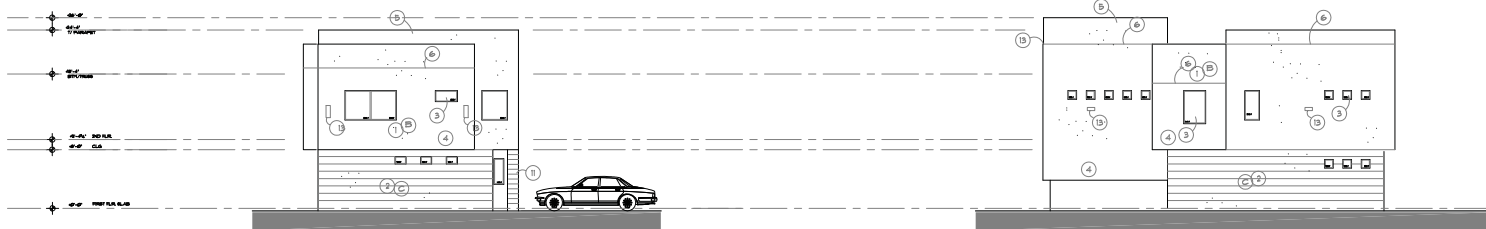

SOUTH ELEV BUILDING D

WEST ELEV BUILDING D

KEY NOTES	
MARK	NOTE
①	ELASTOMERIC STUCCO, MAG 1 COAT. TEXTURE : SAND FINISH.
②	SCORED STUCCO, (HORIZONTAL METAL U CHANNEL) ELASTOMERIC STUCCO, MAG 1 COAT. TEXTURE : SAND FINISH.
③	WINDOW W/ SIZES INDICATED
④	CANTILEVERED (PROJECTED) EDIFICE.
⑤	PARAPET WALL TO SHIELD ROOF EQUIPMENT
⑥	STUCCO CONTROL JOINT
⑦	OVERHEAD 5 SECTIONAL GARAGE DOOR (PAINTED)
⑧	MASONRY LANDSCAPE WALLS
⑨	METAL EYE BROW SHADE PROJECTIONS
⑩	WROUGHT IRON ON THE METAL CANOPY
⑪	HORIZONTAL WOOD SIDING
⑫	ENTRANCE DOOR
□	□ SC LIGHT FIXTURE □ SA LIGHT FIXTURE □ SB LIGHT FIXTURE (SEE PHOTOMETRIC PLAN AND FIXTURE CUT SHEETS)
COLOR / MATERIAL SPECIFICATION	
A	STUCCO, BUILDING BODY COLOR #1 SPEC: MAG-1 COAT R/G/B # 255/247/217 DUNN EDWARDS# DEC 724 (SPANISH WHITE) LRV: 77
B	STUCCO, BUILDING BODY COLOR #2 SPEC: MAG-1 COAT R/G/B # 255/233/165 DUNN EDWARDS# DEC 732 (ASPEN YELLOW) LRV: 70
C	STUCCO, BUILDING BODY COLOR #3 SPEC: MAG-1 COAT SCORED @ 12" HORIZONTALLY R/G/B # 189/180/139 DUNN EDWARDS# DEC 780 (TICKLED CROW) LRV: 45
D	ENTRANCE DOORS SPEC: SOLID CORE WD, PAINTED R/G/B # 145/107/52 DUNN EDWARDS# DES300 (BURMESE GOLD) LRV: 25
D	METAL SUN CONTROL EYEBROWS SPEC: PAINTED STRUCTURAL STEEL R/G/B # 27/25/22 DUNN EDWARDS# DEA 186 (BLACK PEARL) LRV: 25
D	HORIZONTAL WOOD SIDING SPEC: HARDY BD., CEMENT BD. 8" LAP. R/G/B # 123/106/83 DUNN EDWARDS# DE 6371 (BLACK JACK) LRV: 8
E	WINDOWS SPEC: DUAL PANE ENERGY EFFICIENT BLACK ALUM ANODIZED FRAMES SIZES, TYPE NOTED G/ PLANS
P	MASONRY PORCH LOW WALLS SPEC: 8X4 16 MASONRY UNITS COLOR: RGB: 253/198/90

4TH STREET WEST
1801 WEST FOURTH STREET TRAPE AE 86349

SHERBONDY
ART & ARCHITECTURE

404 S. FOURTH STREET
PAINEFIELD IA 52996
TEL: 562-244-0000
DESIGN@SHERBONDY.COM

2/22/14
17:11
SMA
DR
11

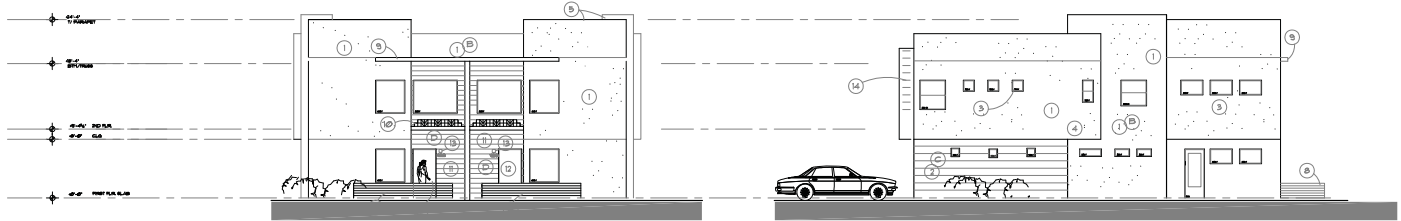

NORTH ELEV BUILDING E

EAST ELEV BUILDING E

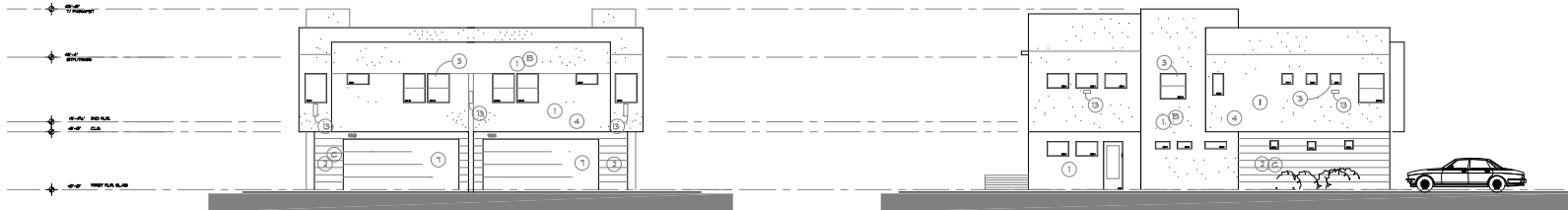

SOUTH ELEV BUILDING E

WEST ELEV BUILDING E

KEY NOTES

MARK	NOTE
①	ELASTOMERIC STUCCO, MAG 1 COAT. TEXTURE : SAND FINISH.
②	SCORED STUCCO, (HORIZONTAL METAL U CHANNEL) ELASTOMERIC STUCCO, MAG 1 COAT. TEXTURE : SAND FINISH.
③	WINDOW W/ SIZES INDICATED
④	CANTILEVERED (PROJECTED) EDIFICE.
⑤	PARAPET WALL TO SHIELD ROOF EQUIPMENT
⑥	STUCCO CONTROL JOINT
⑦	OVERHEAD 5 SECTIONAL GARAGE DOOR (PAINTED)
⑧	MASONRY LANDSCAPE WALLS
⑨	METAL EYE BROW SHADE PROJECTIONS
⑩	WROUGHT IRON ON THE METAL CANOPY
⑪	HORIZONTAL WOOD SIDING
⑫	ENTRANCE DOOR
☐	☐ SC LIGHT FIXTURE ☐ SA LIGHT FIXTURE ☐ SB LIGHT FIXTURE (SEE PHOTOMETRIC PLAN AND FIXTURE CUT SHEETS)
COLOR / MATERIAL SPECIFICATION	
Ⓐ	STUCCO, BUILDING BODY COLOR #1 SPEC: MAG-1 COAT R/G/B # 255/247/217 DUNN EDWARDS# DEC 724 (SPANISH WHITE) LRV: 77
Ⓑ	STUCCO, BUILDING BODY COLOR #2 SPEC: MAG-1 COAT R/G/B # 255/233/165 DUNN EDWARDS# DEC 732 (ASPEN YELLOW) LRV: 70
Ⓒ	STUCCO, BUILDING BODY COLOR #3 SPEC: MAG-1 COAT SCORED @ 12" HORIZONTALLY R/G/B # 189/180/139 DUNN EDWARDS# DEC 780 (TICKLED CROW) LRV: 45
Ⓓ	ENTRANCE DOORS SPEC: SOLID CORE WD, PAINTED R/G/B # 145/107/52 DUNN EDWARDS# DES300 (BURMESE GOLD) LRV: 25
Ⓔ	METAL SUN CONTROL EYEBROWS SPEC: PAINTED STRUCTURAL STEEL R/G/B # 27/25/22 DUNN EDWARDS# DEA 186 (BLACK PEARL) LRV: 25
Ⓕ	HORIZONTAL WOOD SIDING SPEC: HARDY BD., CEMENT BD. 8" LAP. R/G/B # 123/106/83 DUNN EDWARDS# DE 6371 (BLACK JACK) LRV: 8
Ⓖ	WINDOWS SPEC: DUAL PANE ENERGY EFFICIENT BLACK ALUM ANODIZED FRAMES SIZES, TYPE NOTED G/ PLANS
Ⓖ	MASONRY PORCH LOW WALLS SPEC: 8X4 16 MASONRY UNITS COLOR: RGB: 253/198/90

4TH STREET WEST
1801 WEST FOURTH STREET TRAPE AE 06831

SHERBONDY
ART & ARCHITECTURE, INC.

4TH & FOURTH STREET
PATERFIELD IA 52996
TEL: 563 244-0092
DESIGN/STUDIO/REG/KEY

PROJECT: 2022/11
DATE: 11-17-22
BY: SAA
SAA

DR
12

BLDG. E EXT. ELEV.

KEY NOTES	
MARK	NOTE
1	ELASTOMERIC STUCCO, MAG. F. COAT, TEXTURE: SAND FINISH
2	SCORED STUCCO (HORIZONTAL METAL U CHANNEL) ELASTOMERIC STUCCO, MAG. F. COAT, TEXTURE: SAND FINISH
3	WINDOW W/ SIZES INDICATED
4	CANTILEVERED (PROJECTED) EDIFICE
5	PARAPET WALL TO SHIELD ROOF EQUIPMENT
6	STUCCO CONTROL JOINT
7	OVERHEAD 5-SECTIONAL GARAGE DOOR (PAINTED)
8	MASONRY LANDSCAPE WALLS
9	METAL EYE-BROW SHADE PROJECTIONS
10	WROUGHT IRON ON THE METAL CANSOPY
11	HORIZONTAL WOOD SIDING
12	ENTRANCE DOOR



② EAST ELEV BUILDING A



② WEST ELEV BUILDING A



② NORTH ELEV BUILDING A



② SOUTH ELEV BUILDING A

4TH STREET WEST
 1301 WEST FOURTH STREET TEMPE AZ 85281



GREGORY J. SWEENEY
 ARCHITECT
 400 S. COUNTY STREET
 PHOENIX, AZ 85004
 602-955-8800
 GREGORY@GREGORYSWEENEY.COM

PROJECT NO. 2024-001
 SHEET NO. 20
 DATE: 08/2024

DR
 OS

BLDG. A (AND B) EXT. ELEV.

KEY NOTES	
MARK	NOTE
①	ELASTOMERIC STUCCO, MAG. 1 COAT, TEXTURE / SAND FINISH.
②	SCORED STUCCO (HORIZONTAL METAL U CHANNEL) ELASTOMERIC STUCCO, MAG. 1 COAT, TEXTURE / SAND FINISH.
③	WINDOW W/ SIZES INDICATED.
④	CANTILEVERED (PROJECTED) EDIFICE.
⑤	PARAPET WALL TO SHIELD ROOF EQUIPMENT.
⑥	STUCCO CONTROL JOINT.
⑦	OVERHEAD & SECTIONAL GARAGE DOOR (PAINTED).
⑧	MASONRY LANDSCAPE WALLS.
⑨	METAL EYE-BROW SHADE PROJECTIONS.
⑩	WROUGHT IRON ON THE METAL CANSY.
⑪	HORIZONTAL WOOD SILING.
⑫	ENTRANCE DOOR.



④ NORTH ELEV BUILDING C



④ EAST ELEV BUILDING C



④ SOUTH ELEV BUILDING C



④ WEST ELEV BUILDING C

4TH STREET WEST
 1301 WEST FOURTH STREET TEMPE AZ 85281

GREGORY J. SMITH
 ARCHITECT
 400 E. SOUTH STREET
 PHOENIX, AZ 85034
 602-955-1000
 WWW.GREGORYSMITH.COM

DR
10

BLDG. C EXT. ELEV.



① NORTH ELEV BUILDING D



② EAST ELEV BUILDING D



③ SOUTH ELEV BUILDING D



④ WEST ELEV BUILDING D

KEY NOTES	
MARK	NOTE
①	ELASTOMERIC STUCCO, MAG. 1 COAT, TEXTURE: SAND FINISH
②	BOPPED STUCCO (HORIZONTAL METAL U CHANNEL) ELASTOMERIC STUCCO, MAG. 1 COAT, TEXTURE: SAND FINISH
③	WINDOW SIZES INDICATED
④	CANTILEVERED / PROJECTED / EDGE
⑤	PARAPET WALL TO SHIELD ROOF EQUIPMENT
⑥	STUCCO CONTROL JOINT
⑦	OVERHEAD SECTIONAL GARAGE DOOR (PAINTED)
⑧	MASONRY LANDSCAPE WALLS
⑨	METAL EYE BROW SHADE PROJECTIONS
⑩	BROUGHT IRON ON THE METAL CANOPY
⑪	HORIZONTAL WOOD SIDING
⑫	ENTRANCE DOOR
⑬	STEP BACK PARAPET

REVISIONS

4TH STREET WEST
1301 WEST FOURTH STREET, TEMPE, AZ 85281



ADD: 4 SOUTH STREET
PHOENIX, AZ 85004
TEL: 602-944-3000
WWW.SHERBORN.COM

DATE: 08/11/11
PROJECT: 110111001
DRAWING: DR
11

BLDG. D EXT. ELEV.



① NORTH ELEV BUILDING E



② EAST ELEV BUILDING E



③ SOUTH ELEV BUILDING E



④ WEST ELEV BUILDING E

KEY NOTES	
MARK	NOTE
①	ELASTOMERIC STUCCO, MAG 1 COAT, TEXTURE - SAND FINISH.
②	SCORED STUCCO (HORIZONTAL METAL CHANNEL) ELASTOMERIC STUCCO, MAG 1 COAT, TEXTURE - SAND FINISH.
③	WINDOW W/ SIZES INDICATED
④	CANTILEVERED (PROJECTED) EDGICE.
⑤	PARAPET WALL TO SHIELD ROOF EQUIPMENT
⑥	STUCCO CONTROL JOINT
⑦	OVERHEAD SECTIONAL GARAGE DOOR (PAINTED)
⑧	MASONRY LANDSCAPE WALLS
⑨	METAL EYE BROW SHADE PROJECTIONS
⑩	WROUGHT IRON ON THE METAL CANOPY
⑪	HORIZONTAL WOOD SIDING
⑫	ENTRANCE DOOR
⑬	STEP BACK PARAPET
⑭	STEPS FOR ROOF ACCESS

4TH STREET WEST
 1301 WEST FOURTH STREET TEMPE AZ 85281



SHERBOBY ENGINEERING

ARCHITECT

1482

STATE OF ARIZONA

1301 WEST FOURTH STREET
 PHOENIX, AZ 85281
 TEL: 480-944-7000
 WWW.SHERBOBY.COM

DATE: 02/12/2014

PROJECT: BLDG. E EXT. ELEV.

DR 12

BLDG. E EXT. ELEV.

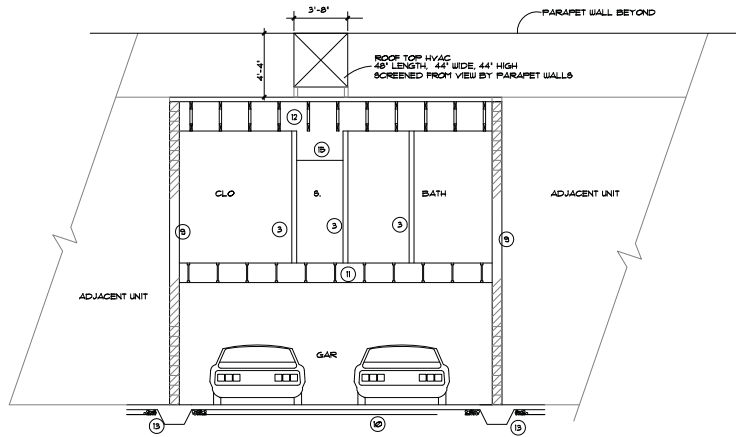
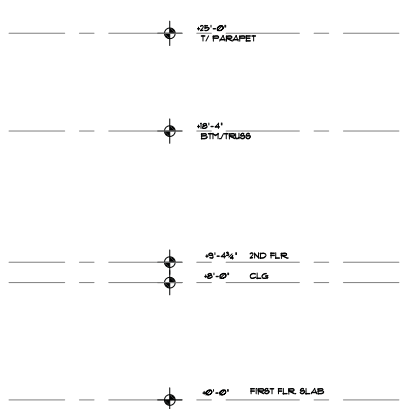

01
06 SEC. BUILDING TYP 1

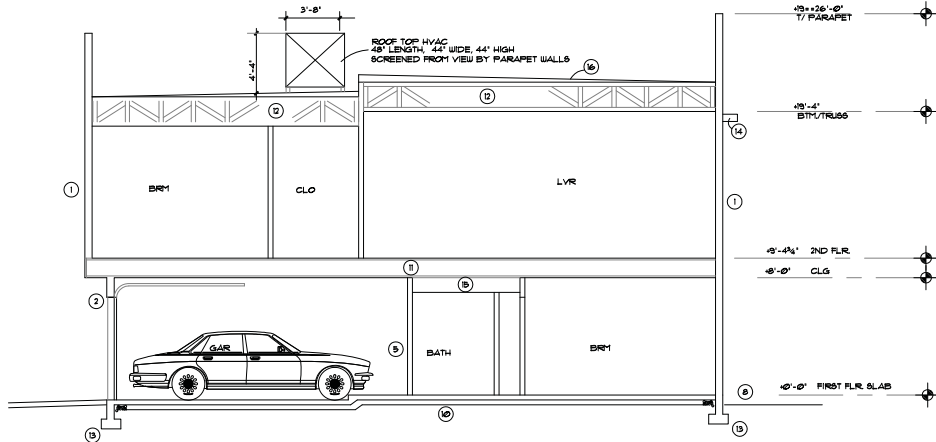
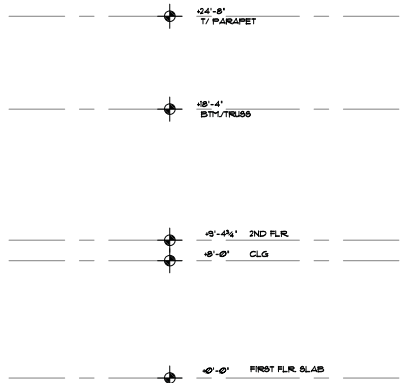

02
06 SEC. BUILDING TYP 1

KEY NOTES

MARK	NOTE
①	EXT. WALLS AT LIVABLE AREA- 2X4 STUDS (OR 2X6 @ 2-STORY CONDITIONS) STUDS @ 16" O.C. W/ FG. BATTS BTWN STUDS EXT. SIDE: 3/8" OSB SHEATHING EXT. SIDE: 1" RIGID INSUL. BD. W/ LATH & 1-COAT STUCCO SYSTEM. INT. SIDE: 1/2" GYP. BOARD TOTAL R VALUE (2X4 WALL) = R-11
②	EXT. WALLS AT GARAGE- 2X4 STUDS @ 16" O.C. W/ FG. BATTS INSUL. BTWN STUDS EXT. SIDE: 3/8" OSB SHEATHING EXT. SIDE: 1" RIGID INSUL. BD. W/ LATH & 1-COAT STUCCO SYSTEM. INT. SIDE: 5/8" TYPE X GYP. BOARD TAPED
③	INTERIOR WALLS- 2X4 WALLS AT 24" O.C. W/ 1/2" GYP. BD. EA. SIDE.
④	PLUMBING WALLS- 2X4 WALLS AT 16" O.C. W/ WP. 1/2" GYP. ON PLUMB. FIX SIDE(S) R-II SOUND BATTS BTW. STUDS (TYP.)
⑤	WALLS BTWN LIVABLE & NON-LIVABLE- 2X4 STUDS AT 16" O.C. W/ R-II FG. INSUL. BTWN STUDS 1/2" GYP. BOARD TAPED (EA. SIDE) 5/8" TYPE X GYP. BOARD TAPED (GARAGE SIDE)
⑥	INTERIOR WALLS (SOUND WALLS) 2X4 WALLS AT 16" O.C. W/ 1/2" GYP. BD. EA. SIDE. W/ R-II SOUND BATTS
⑦	STUCCO, 1 COAT, TEXTURE : SAND FINISH.
⑧	FINISH GRADE, SLOPE AWAY FROM BUILDING
⑨	WALL BETWEEN DWELLING UNITS 8" CMU WALL W/ SAND FILL ALL UNREINFORCED CELLS. 2 HR. FIRE RATING
⑩	4" CONC. O/ 4" ABC
⑪	WOOD FLOOR TRUSSES
⑫	PREFABRICATED MANUFACTURED WD. TRUSSES W/ 5/8" CDX PLYWD. ROOF SHEATHING 24" O.C., 1/2" FT. SLOPE
⑬	WALL FOOTINGS
⑭	METAL EYE BROW PROJECTIONS
⑮	DROPPED CEILING/ SOFFIT O/ 2X FRAMING
⑯	ROOF SLOPE (RIGID FOAM)

REVISIONS

--	--

4TH STREET WEST
1801 WEST FOURTH STREET TRAPE AE 80549



SHERROD
ART T. SHERROD
14802
OOR OVEN
2015
SHERROD
ART T. SHERROD

APP. 5 FOURTH STREET
PANAMA CITY 32380
TEL: 904-246-0092
DESIGN@SHERROD.COM

2025.09.25 4:51 PM
FILE: 25.09.25

PROFESSIONAL
1/2" = 1'-0"
SCALE
SMA
DR
06

DESIGN REV

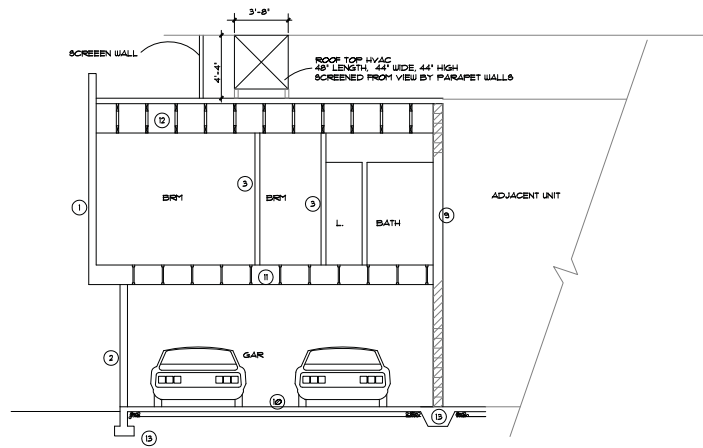
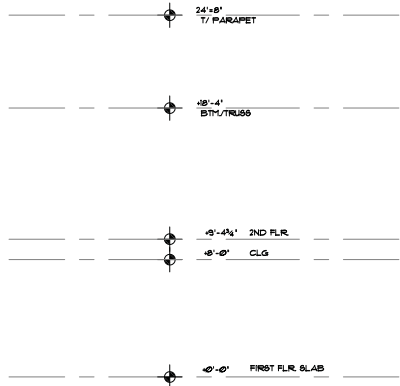

01
01 SEC. BUILDING TYP 1

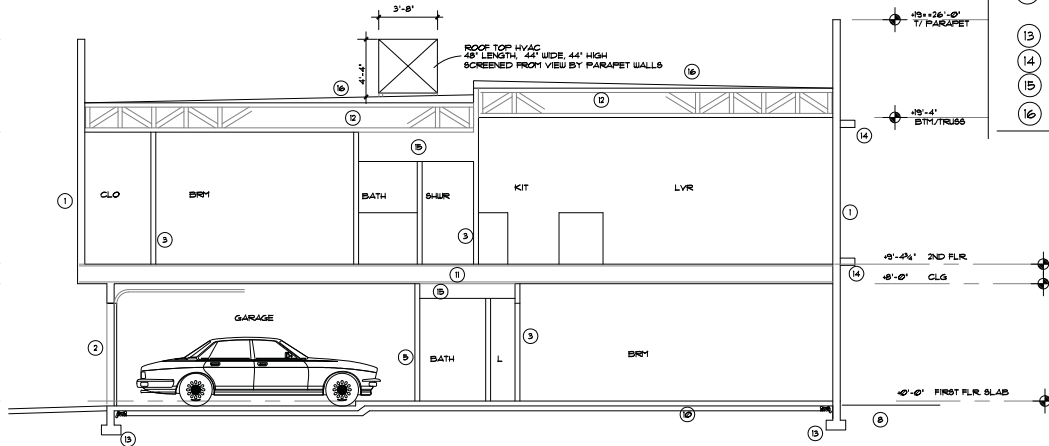
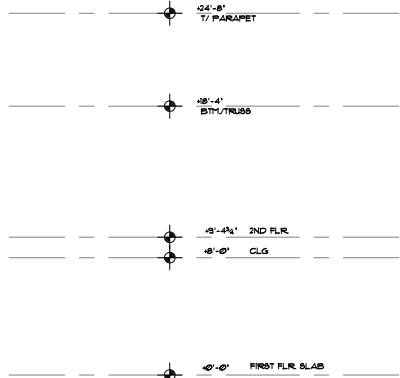

02
01 SEC. BUILDING TYP 1

KEY NOTES

MARK	NOTE
①	EXT. WALLS AT LIVABLE AREA- 2X4 STUDS (OR 2X6 @ 2-STORY CONDITIONS) STUDS @ 16" O.C. W/ FG. BATTS BTWN STUDS EXT. SIDE: 3/8" OSB SHEATHING EXT. SIDE: 1" RIGID INSUL. BD. W/ LATH & 1-COAT STUCCO SYSTEM. INT. SIDE: 1/2" GYP. BOARD TOTAL R VALUE (2X4 WALL): R-11
②	EXT. WALLS AT GARAGE- 2X4 STUDS @ 16" O.C. W/ FG. BATTS INSUL. BTWN STUDS EXT. SIDE: 3/8" OSB SHEATHING EXT. SIDE: 1" RIGID INSUL. BD. W/ LATH & 1-COAT STUCCO SYSTEM. INT. SIDE: 5/8" TYPE X GYP. BOARD TAPED
③	INTERIOR WALLS- 2X4 WALLS AT 24" O.C. W/ 1/2" GYP. BD. EA. SIDE.
④	PLUMBING WALLS- 2X4 WALLS AT 16" O.C. W/ WP. 1/2" GYP. ON PLUMB. FIX SIDE(S) R-II SOUND BATTS BTWN STUDS (TYP.)
⑤	WALLS BTWN LIVABLE & NON-LIVABLE- 2X4 STUDS AT 16" O.C. W/ R-II FG. INSUL. BTWN STUDS 1/2" GYP. BOARD TAPED (EA. SIDE) 5/8" TYPE X GYP. BOARD TAPED (GARAGE SIDE)
⑥	INTERIOR WALLS (SOUND WALLS) 2X4 WALLS AT 16" O.C. W/ 1/2" GYP. BD. EA. SIDE. W/ R-II SOUND BATTS
⑦	STUCCO, 1 COAT, TEXTURE : SAND FINISH.
⑧	FINISH GRADE, SLOPE AWAY FROM BUILDING
⑨	WALL BETWEEN DWELLING UNITS 8" CMU WALL W/ SAND FILL ALL UNREINFORCED CELLS. 2 HR. FIRE RATING
⑩	4" CONC. O/ 4" ABC
⑪	WOOD FLOOR TRUSSES
⑫	PREFABRICATED MANUFACTURED WD. TRUSSES W/ 5/8" CDX PLYWD. ROOF SHEATHING 24" O.C., 1/2" FT. SLOPE
⑬	WALL FOOTINGS
⑭	METAL EYE BROW PROJECTIONS
⑮	DROPPED CEILING/ SOFFIT O/ 2X FRAMING
⑯	ROOF SLOPE (RIGID FOAM)

REVISIONS:

4TH STREET WEST
1801 WEST FOURTH STREET TRAPE AE 80549

REGISTERED ARCHITECT
14802
DAN OWEN
SPECIAL LICENSE

SHERROD
ART & ARCHITECTURE

404 S. FORTH STREET
TAMPAFLD IA 33690
TEL: 813 246-0092
DESIGN@SHERRODARCHITECT

PROFESSIONAL
176-FL
SSEA
DR
07

DESIGN REV.

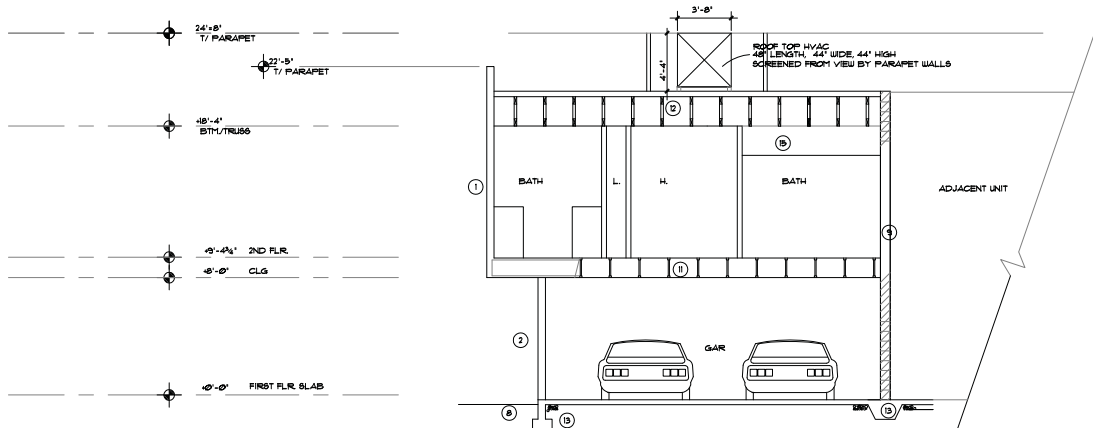

01
06 **SEC. BUILDING TYPE 3**

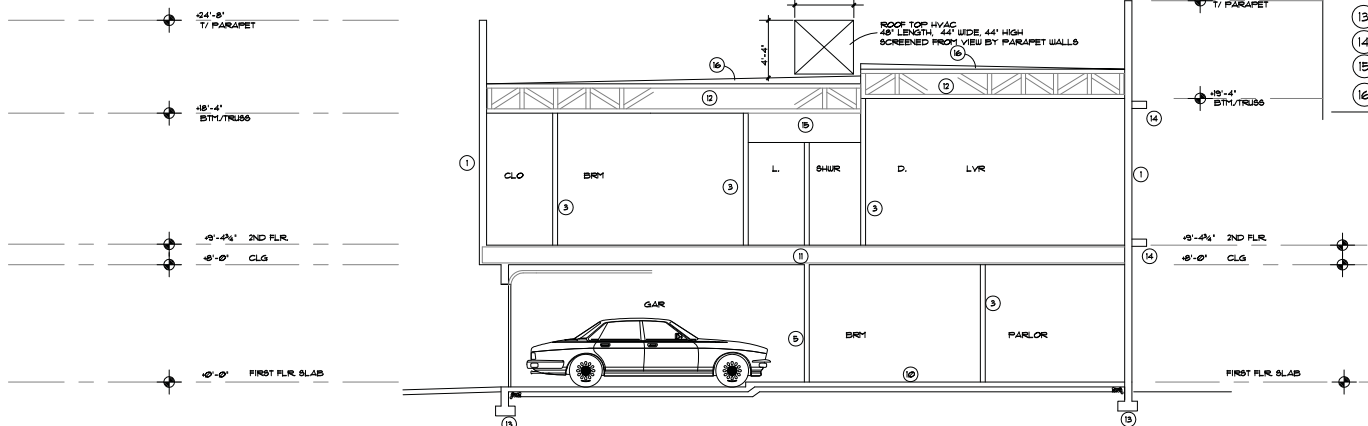

02
06 **SEC. BUILDING TYPE 3**

KEY NOTES

MARK	NOTE
1	EXT. WALLS AT LIVABLE AREA- 2X4 STUDS (OR 2X6 @ 2-STORY CONDITIONS) STUDS @ 16' O.C. W/ F.G. BATTS BTWN STUDS EXT. SIDE: 3/8" OSB SHEATHING EXT. SIDE: 1" RIGID INSUL. BD. W/ LATH & 1-COAT STUCCO SYSTEM. INT. SIDE: 1/2" GYP. BOARD TOTAL R VALUE (2X4 WALL) = R-11
2	EXT. WALLS AT GARAGE- 2X4 STUDS @ 16' O.C. W/ F.G. BATTS INSUL. BTWN STUDS EXT. SIDE: 3/8" OSB SHEATHING EXT. SIDE: 1" RIGID INSUL. BD. W/ LATH & 1-COAT STUCCO SYSTEM. INT. SIDE: 5/8" TYPE X GYP. BOARD TAPED
3	INTERIOR WALLS- 2X4 WALLS AT 24' O.C. W/ 1/2" GYP. BD. EA. SIDE.
4	PLUMBING WALLS- 2X4 WALLS AT 16' O.C. W/ W.P. 1/2" GYP. ON PLUMB. FIX SIDE(S) R-11 SOUND BATTS BTWN STUDS (TYP.)
5	WALLS BTWN LIVABLE & NON-LIVABLE- 2X4 STUDS AT 16' O.C. W/ R-11 F.G. INSUL. BTWN STUDS 1/2" GYP. BOARD TAPED (EA. SIDE) 5/8" TYPE X GYP. BOARD TAPED (GARAGE SIDE)
6	INTERIOR WALLS (SOUND WALLS) 2X4 WALLS AT 16' O.C. W/ 1/2" GYP. BD. EA. SIDE. W/ R-11 SOUND BATTS
7	STUCCO, 1 COAT, TEXTURE : SAND FINISH.
8	FINISH GRADE, SLOPE AWAY FROM BUILDING
9	WALL BETWEEN DUELLING UNITS 8' C.M.U. WALL W/ SAND FILL. ALL UNREINFORCED CELLS. 2 HR. FIRE RATING
10	4' CONC. O/ 4' ABC
11	WOOD FLOOR TRUSSES
12	PREFABRICATED MANUFACTURED W.D. TRUSSES W/ 5/8" CDX FLTWD. ROOF SHEATHING 24' O.C., 1/2" FT. SLOPE
13	WALL FOOTINGS
14	METAL EYE BROW PROJECTIONS
15	DROPPED CEILING/ SOFFIT O/ 2X FRAMING
16	ROOF SLOPE (RIGID FOAM)

REVISIONS:

4TH STREET WEST
1801 WEST FOURTH STREET TRAPE AE 80589



SHERBONDY
ART T. SHERBONDY

404 S. FORTH STREET
PAINESVILLE, OH 44094
TEL: 440.346.2002
2016051010 DR02NET

PROFESSIONAL
1/2" = 1'-0"
SMA
DR



CONTEXT PHOTOS AND GRAPHICS FOR 4TH STREET WEST



11



10

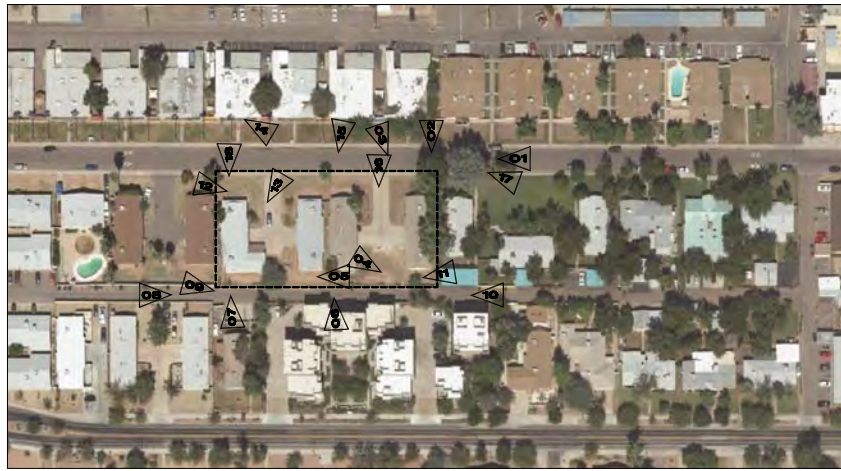

01



02



09



08



07



06



05



04



03



12



13



14



15



16



17



18

4TH STREET WEST
1801 WEST FOURTH STREET, TEMPE, AZ - 85281



404 S FOURTH STREET
PAINTFIELD, IN 47256
TEL: 812-244-2100
DESIGNATED ACCOUNT



DEV. PLAN REVIEW

October 29, 2014

Summary of meeting at Westside Community Center, Tempe, AZ 85282

RE: Neighborhood meeting for 1301 West 4th St., Tempe, AZ 85282 (15 units)

The meeting time was 6:30PM to 7:30PM, Wednesday, October 29, 2014. I, Thomas Goscicki, the applicant, conducted the meeting and Diana Kaminski, the City of Tempe City Planner, was present to address any questions. The first to arrive was Bill Butler, President of the Sunset Riverside Community Association (the neighborhood association where the proposed project is located).

Other participants began to arrive at 6:30 pm and there were a total of eight (8) people in attendance including myself and Ms. Kaminski. Four of the attendees were local /neighborhood property owners of my existing (completed) project at 1300 W. 5th St., Tempe, AZ 85282. There was much interest in the new project and questions were asked as to the similarity of the 5th St. West units, the guest parking, parking for each unit, type of units (2 or 3 bedrooms) size of the units and landscaping. Being familiar with my previous work at 5th St. West they were pleased to know that I would take the same degree of care and attention to detail in this new project while creating a project that was compatible to the neighborhood. One party expressed an interest in purchasing a unit. All questions were answered and there were no complaints and all attendees were very positive and supportive of the new project.

Ms. Kaminski left at the scheduled ending time of 7:30PM and the meeting continued until approximately 7:45PM.

Respectfully,

Thomas A. Goscicki