

**CITY OF TEMPE  
DEVELOPMENT REVIEW COMMISSION**

Meeting Date: 10/11/2016  
Agenda Item: 3

**ACTION:** Request for Development Plan Review consisting of new retail store for **GUITAR CENTER AT EMERALD CENTER**, located at 8550 South Emerald Drive. The applicant is Bret Ryan, LGE Design Group.

**FISCAL IMPACT:** There is no fiscal impact on City funds.

**RECOMMENDATION:** Approval, subject to conditions

**BACKGROUND INFORMATION:** **GUITAR CENTER AT EMERALD CENTER (PL160300)** is located between Elliot and Warner roads, within the Emerald Center Business Park, south of Ikea and adjacent to Total Wine and More. The property is part of the Planned Area Development of Emerald Center and is zoned RCC, Regional Commercial Center, within the Southwest Overlay District. The request is for the design of the proposed commercial retail development and includes the following:

1. Development Plan Review including site plan, building elevations, and landscape plan

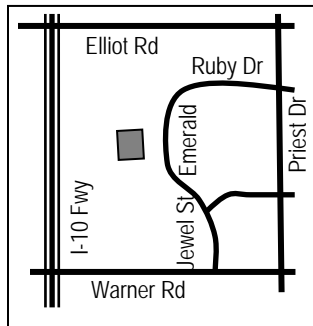

Existing Property Owner	Tom Tait, Emerald I-10, LLC
Applicant	Bret Ryan, LGE Design Group
Current Zoning District	Reginal Commercial Center, with Planned Area Development Overlay in the Southwest Tempe Overlay District
Gross / Net site area	13.67 acres (1.18 acres Gutar Center)
Total Building Area	107,457 s.f.
Individual Building Area	15,321 s.f. (Guitar Center)
Lot Coverage	18% (Max 50% allowed in PAD)
Building Height	38 feet (160 feet allowed in PAD)
Building Setbacks	275' east front, 63' west rear, 53' south side, 536' north side (25 feet setback minimum allowed in PAD)
Landscape area	15.18% (15% minimum required)
Vehicle Parking	51 spaces provided within the existing shared parking for the development (51 required)
Bicycle Parking	2 spaces (2 required)

**ATTACHMENTS:** Development Project File

**STAFF CONTACT(S):** Diana Kaminski, Senior Planner (480) 858-2391

Department Director: Jeff Tamulevich, Interim Community Development Director  
 Prepared by: Diana Kaminski, Senior Planner  
 Reviewed by: Suparna Dasgupta, Principal Planner

## COMMENTS:

The site is located between Elliot and Warner roads, along Emerald Drive, east of the I-10 Freeway and west of Priest Drive, within the Emerald Center Business Park. Ikea is located north of Lot 1B; Texas Roadhouse and Mattress Firm are located on Lot 1B as part of a Planned Area Development. Vacant land is to the south, and Main Event is to the east across Emerald Drive. The proposed development will be an addition to the existing east side wall of Total Wine and More and Dick's Sporting Goods. A vacant site will remain to the east of Guitar Center and Emerald Drive until further tenant additions are made. There is currently one Guitar Center retailer in Tempe. The request is for a Development Plan Review for a 15,321 s.f. retail building addition including the elevations, landscape design and site plan on 1.18 net acres. The applicant is requesting the Development Review Commission approve the Development Plan Review for Guitar Center at Emerald Center. For further processing, the applicant will need to amend the Planned Area Development, which will be administratively reviewed.

## PRELIMINARY SITE PLAN REVIEW

8/3/2016 Site Plan Review comments included standard technical details and a request for enhancement of the elevations using the existing color and material palette of the existing building. Concern was expressed that the proposed color was too white, and that the eastern wall, the side most visible to the street lacked architectural detail. In response, the applicant met with staff and modified the colors and materials to conform to the existing design palette. The eastern wall of The Guitar Center may eventually become an interior wall for the next addition to this building; however, the timing of this is undetermined and the existing wall of Total Wine has been left exposed since constructed in 2009. The applicant enhanced the elevation with architectural detail and proposed a few ground level plants that could be removed when new development occurs.

## PUBLIC INPUT

- Neighborhood meeting was not required for this request

## PROJECT ANALYSIS

### DEVELOPMENT PLAN REVIEW

This site is part of the Emerald Center Business Park Planned Area Development. Images of the existing surrounding buildings are provided within the attachments for contextual reference. The color scheme and materials are designed to meet the Emerald Center corporate design of the existing retail building.

### Site Plan

The net area of the site is 50,793 s.f. with a proposed 15,321 s.f. building. The infrastructure within Lot 1B for the site has already been established. There is a sidewalk extending from Dick's Sporting Goods to Emerald Drive, providing pedestrian access to the building. Street and drive entrances are already built, along with water and electrical networks. The site faces north and sits on the south side of an existing shared parking lot. The entrance to this lot is located to the east on Emerald Drive. Solid waste and fire circulation have been reviewed for access requirements.

### Building Elevations

The maximum building height allowed within the RCC district is 75 feet with an additional 25 feet in the Southwest Tempe Overlay District. The PAD for Emerald Center allows up to 160 feet in height. The proposed building is one story at a height of 38 feet above grade. The north elevation is a rust or brick painted stucco EFIS product for the primary building material and with a beige accent to match Dick's Sporting Goods and Total Wine and More. The building entrance columns and front wainscot are brick colored brick veneer, which wraps around the eastern side of the building for a portion of the north end. A steel tube eyebrow frame painted to match Dick's Sporting Goods' green color will make up the front canopy entrance. A framed woven steel mesh panel painted the same shade of green is placed above the canopy and provides a place for tenant signage. The east and south elevations are a mix of smooth and split face painted concrete masonry block. The eastern wall includes a geometric abstract pattern reflective of a guitar fret and strings that form bands of decorative masonry alternating in taupe, brick and beige tones, framed by a darker warm grey column pop-out terminating the design at each end.

## Landscape Plan

The site has existing established landscape, a new landscape island at the entrance of the building addition will include Swan Hill Olive trees, muhlenbergia grass, red yucca and gold lantana to match the existing plants on site. Agave are shown on the eastern side of the building addition toward the north end as a temporary enhancement of the site until further development occurs.

Section 6-306 D Approval criteria for Development Plan Review (*in italics*):

1. *Placement, form, and articulation of buildings and structures provide variety in the streetscape*; the retail building is an attached extension to an existing structure, parking and street access. The building elevations have variation in massing and design. The architecture is similar to the multi-tenant and large box uses. The architectural enhancement of the eastern elevation facing Emerald Drive provides visual interest to the streetfront.
2. *Building design and orientation, together with landscape, combine to mitigate heat gain/retention while providing shade for energy conservation and human comfort*; the building has a north-facing orientation and shared western wall that will minimize sunlight exposure to the building. A landscape island is proposed on the north side of the building to provide shade and greenery along the sidewalk entrance to the building. No windows are located on the south side, which has the greatest solar exposure.
3. *Materials are of a superior quality, providing detail appropriate with their location and function while complementing the surroundings*; the materials and colors for this project were chosen to tie in to the existing buildings directly to the north and west. The red brick, stucco, concrete masonry and metal accents are similar in quality and color to the materials used on the adjacent building.
4. *Buildings, structures, and landscape elements are appropriately scaled, relative to the site and surroundings*; the building is 38 feet high above grade at its tallest point. The building is similar in scale relative to the adjacent building and other buildings within the Emerald Center. The landscape conforms to the requirements of the Emerald Center street front and integrates similar plants found in surrounding landscape context.
5. *Large building masses are sufficiently articulated so as to relieve monotony and create a sense of movement, resulting in a well-defined base and top, featuring an enhanced pedestrian experience at and near street level*; the size of the building continues to grow with each additional tenant; the south side is the back of house, replicating existing conditions but broken up by color and changes in wall plane. The north side is divided by tenant with clearly defined frontages integrated by common architectural materials and colors. The east side provides a sense of rhythm and movement through the use of alternating colors of masonry to create a pattern visible from the street front and parking area until such time as further additions to the building occur.
6. *Building facades provide architectural detail and interest overall with visibility at street level (in particular, special treatment of windows, entries and walkways with particular attention to proportionality, scale, materials, rhythm, etc.) while responding to varying climatic and contextual conditions*; the building provides a strong delineation of the base and top of form on the north elevation and a strong proportional pattern on the east elevation.
7. *Plans take into account pleasant and convenient access to multi-modal transportation options and support the potential for transit patronage*; the building addition is located within an existing Planned Area Development with no new transportation infrastructure, but does provide sidewalk connectivity to bus services in the area.
8. *Vehicular circulation is designed to minimize conflicts with pedestrian access and circulation, and with surrounding residential uses*; the site is designed with parking in the front, delivery and service uses to the rear and shaded pedestrian access along the building front to separate traffic by use and type.
9. *Plans appropriately integrate Crime Prevention Through Environmental Design principles such as territoriality, natural surveillance, access control, activity support, and maintenance*; the back of house area remains remote from visibility, and may require camera surveillance; police staff has reviewed the project for general conformance with safe design.

10. *Landscape accents and provides delineation from parking, buildings, driveways and pathways; the entrance is enhanced with additional landscape, the remainder of the site is existing.*
11. *Signs have design, scale, proportion, location and color compatible with the design, colors, orientation and materials of the building or site on which they are located; and signs will be addressed by separate permit and will comply with requirements of the established sign package for Emerald Center.*
12. *Lighting is compatible with the proposed building(s) and adjoining buildings and uses, and does not create negative effects.* Lighting for the site is existing, new lighting will be provided at the entrance/exit points to the new addition and comply with code requirements for safe illumination.

#### **CONCLUSION:**

Based on the information provided and the above analysis, staff recommends approval of the requested Development Plan Review. This request meets the required criteria and will conform to the conditions.

#### **REASONS FOR APPROVAL:**

1. The project meets the General Plan Projected Land Use for this site.
2. The project will meet the development standards required under the Zoning and Development Code and Southwest Overlay District.
3. The proposed project meets the approval criteria for a Development Plan Review.

**DEVELOPMENT PLAN REVIEW CONDITIONS OF APPROVAL:** EACH NUMBERED ITEM IS A CONDITION OF APPROVAL. THE DECISION-MAKING BODY MAY MODIFY, DELETE OR ADD TO THESE CONDITIONS.

#### **General**

1. A Fifth Amended Planned Area Development Overlay for Emerald Center Lot 1B is required and shall be submitted within sixty (60) days of Development Plan Review approval. The amendment shall be put into proper engineered format with appropriate signature blanks and kept on file with the City of Tempe's Community Development Department prior to issuance of building permits.
2. Except as modified by conditions, development shall be in substantial conformance with the site plan, landscape plan and building elevations dated August 22, 2016. Minor modifications may be reviewed through the plan check process of construction documents; major modifications will require submittal of a Development Plan Review.
3. Art in Private Development is required. The developer may elect to install on-site artwork or provide an Arts Fund contribution. If the property owner elects to install on-site artwork, the Preliminary Art Project Plan is required before a building permit is issued.

#### **Site Plan**

4. The site plan is approved as submitted (August 22, 2016), minor modifications may be reviewed through the plan check process of construction documents; major modifications will require submittal of a Development Plan Review.
5. Provide service yard and mechanical (cooling tower/generator) yard walls that are at least 8'-0" tall as measured from adjacent grade and are at least the height of the equipment being enclosed, whichever is greater. Verify height of equipment and mounting base to ensure that wall height is adequate to fully screen the equipment.
6. Provide gates of steel vertical picket, steel mesh, steel panel or similar construction. Where a gate has a screen function and is completely opaque, provide vision portals for visual surveillance. Provide gates of height that match that of the adjacent enclosure walls. Review gate hardware with Building Safety and Fire staff and design gate to resolve lock and emergency ingress/egress features that may be required.
7. Utility equipment boxes for this development shall be finished in a neutral color (subject to utility provider approval) that compliments the coloring of the buildings.

- Place exterior, freestanding reduced pressure and double check backflow assemblies in pre-manufactured, pre-finished, lockable cages (one assembly per cage). If backflow prevention or similar device is for a 3" or greater water line, delete cage and provide a masonry or concrete screen wall following the requirements of Standard Detail T-214.

### **Building Elevations**

- The materials and colors are approved as presented (August 22, 2016):
  - Roof – flat with parapet
  - North elevation and east corner - primary building - Exterior Stucco System painted Dunn Edwards to match Dryvit Color Monestary Brown 381 (beige color to match remainder of existing building)
  - North elevation entry - Exterior Stucco System painted Dunn Edwards to match Frazee Anthem CLV1111N (rust /brick)
  - North elevation accent - Exterior Stucco System painted Dunn Edwards Barnwood Gray DET620 (medium taupe)
  - North elevation lintel and trellis – Painted metal Dunn Edwards painted similar to Sherwin Williams Country Squire SW6475 (to match Dick's Sporting Goods Green)
  - North elevation wainscot and columns and East elevation corner wrap– Brick Veneer field Beldon #503-505 standard, with #127 LaFarge Masonry colored mortar.
  - North elevation aluminum storefront glazing.
  - East elevation primary building and south elevation secondary building – Smooth face 8x8x16 concrete masonry units painted Dunn Edwards Barnwood Gray DET620 (medium taupe)
  - East elevation secondary building and south elevation tertiary building - Smooth face 8x8x16 concrete masonry units painted Dunn Edwards painted to match Dryvit Color Monestary Brown 381 (beige color to match remainder of existing building)
  - East elevation south end and South elevation primary building - Smooth face 8x8x16 concrete masonry units painted Dunn Edwards to match Frazee Anthem CLV1111N (rust /brick)
  - East elevation vertical accents – Split face 8x8x16 concrete masonry units painted Dunn Edwards Grange Hall DET695 (dark taupe)
  - East elevation vertical accents - Smooth face 8x8x16 concrete masonry units painted to match Frazee Anthem CLV1111N (rust /brick)
  - East elevation horizontal accents - Split face 8x8x16 concrete masonry units painted Dunn Edwards Barnwood Gray DET620 (medium taupe)Provide primary building colors and materials with a light reflectance value of 75 percent or less. Additions or modifications may be submitted for review during building plan check process.
- Provide secure roof access from the interior of the building. Do not expose roof access to public view.
- Conceal roof drainage system within the interior of the building.
- Incorporate lighting, address signs, and incidental equipment attachments (alarm klaxons, security cameras, etc.) where exposed into the design of the building elevations. Exposed conduit, piping, or related materials is not permitted.
- Locate the electrical service entrance section (S.E.S.) inside the building or inside a secure yard that is concealed from public view.
- Upper/lower divided glazing panels in exterior windows at grade level, where lower glass panes are part of a divided pane glass curtain-wall system, shall be permitted only if laminated glazing at these locations is provided.

### **Lighting**

- This project shall follow requirements of ZDC Part 4, Chapter 8, Lighting, unless otherwise conditioned.
- Illuminate building entrances from dusk to dawn to assist with visual surveillance at these locations.

### **Landscape**

- The plant palette is approved as proposed and specified on the landscape plan. Any additions or modifications may be submitted for review during building plan check process.

18. The six *Agave americana* shown on the renderings (attachments 11 & 12) shall be planted per the rendering as interim planting until new development occurs adjacent to this building wall.
19. Irrigation notes:
  - a. Provide dedicated landscape water meter.
  - b. Provide pipe distribution system of buried rigid (polyvinylchloride), not flexible (polyethylene). Use of schedule 40 PVC mainline and class 315 PVC ½" feeder line is acceptable. Class 200 PVC feeder line may be used for sizes greater than ½". Provide details of water distribution system.
  - c. Locate valve controller in a vandal resistant housing.
  - d. Hardwire power source to controller (a receptacle connection is not allowed).
  - e. Controller valve wire conduit may be exposed if the controller remains in the mechanical yard.
  - f. Repair existing irrigation system (on site or in the adjacent public right of ways) where damaged by work of this project. Provide temporary irrigation to existing landscape on site or on street frontage for period of time that irrigation system is out of repair. Design irrigation so that the existing plants are irrigated as part of the reconfigured system at the conclusion of this construction.
20. Include requirement to de-compact soil in planting areas on site and in public right of way and remove construction debris from planting areas prior to landscape installation.
21. Top dress planting areas with a rock or decomposed granite application. Provide rock or decomposed granite of 2" uniform thickness. Provide pre-emergence weed control application and do not underlay rock or decomposed granite application with plastic.
22. Trees shall be planted a minimum of 20'-0" from any existing or proposed public water or sewer lines. The tree planting separation requirements may be reduced from the waterline upon the installation of a linear root barrier, a minimum of 6'-0" parallel from the waterline, or around the tree. The root barrier shall be a continuous material, a minimum of 0.08" thick, installed 0'-2" above finish grade to a depth of 8'-0" below grade. Final approval subject to determination by the Public Works, Water Utilities Division.

### Addressing

23. Provide address sign(s) on the north and south elevations.
  - a. Conform to the following for building address signs:
    - 1) Provide street number only, not the street name
    - 2) Compose of 12" high individual mount, metal reverse pan channel characters.
    - 3) Self-illuminated or dedicated light source.
    - 4) Coordinate address signs with trees, vines, or other landscaping, to avoid any potential visual obstruction.
    - 5) Do not affix numbers or letters to elevation that might be mistaken for the address.
  - b. Utility meters shall utilize a minimum 1" number height in accordance with the applicable electrical code and utility company standards.

### CODE/ORDINANCE REQUIREMENTS:

THE ITEMS BELOW REFER TO EXISTING CODE OR ORDINANCES THAT PLANNING STAFF OBSERVES ARE PERTINENT TO THIS CASE. THESE ITEMS ARE INCLUDED TO ALERT THE DESIGN TEAM AND ASSIST IN OBTAINING A BUILDING PERMIT AND ARE NOT AN EXHAUSTIVE LIST.

**SITE PLAN REVIEW:** Verify all comments by the Public Works Department, Community Development Department, and Fire Department given on the Preliminary Site Plan Review. If questions arise related to specific comments, they should be directed to the appropriate department, and any necessary modifications coordinated with all concerned parties, prior to application for building permit. Construction Documents submitted to the Building Safety Division will be reviewed by planning staff to ensure consistency with this Design Review approval prior to issuance of building permits.

DEADLINE: Development plan approval shall be void if the development is not commenced or if an application for a building permit has not been submitted, whichever is applicable, within twelve (12) months after the approval is granted or within the time stipulated by the decision-making body. The period of approval is extended upon the time review limitations set forth for building permit applications, pursuant to Tempe Building Safety Administrative Code, Section 8-104.15. An expiration of the building permit application will result in expiration of the development plan.

STANDARD DETAILS:

- Access to Tempe Supplement to the M.A.G. Uniform Standard Details and Specifications for Public Works Construction, at this link: <http://www.tempe.gov/city-hall/public-works/engineering/standards-details> or purchase book from the Public Works Engineering Division.
- Access to refuse enclosure details DS116 and DS118 and all other Development Services forms at this link: <http://www.tempe.gov/city-hall/community-development/building-safety/applications-forms>. The enclosure details are under Civil Engineering & Right of Way.

BASIS OF BUILDING HEIGHT: Measure height of buildings from top of curb at a point adjacent to the center of the front property line.

PUBLIC ART: Provide public art for this development in conformance with the Art in Private Development Ordinance and ZDC Sec. 4-407 and ZDC Appendix D. Contact the Community Services Cultural Services Division regarding implementation of this requirement prior to receiving building permits.

WATER CONSERVATION: Under an agreement between the City of Tempe and the State of Arizona, Water Conservation Reports are required for landscape and domestic water use for the non-residential components of this project. Have the landscape architect and mechanical engineer prepare reports and submit them with the construction drawings during the building plan check process. Report example is contained in Office Procedure Directive # 59. Refer to this link: [www.tempe.gov/modules/showdocument.aspx?documentid=5327](http://www.tempe.gov/modules/showdocument.aspx?documentid=5327). Contact Public Works Department, Water Conservation Division with questions regarding the purpose or content of the water conservation reports.

HISTORIC PRESERVATION: State and federal laws apply to the discovery of features or artifacts during site excavation (typically, the discovery of human or associated funerary remains). Contact the Historic Preservation Officer with general questions. Where a discovery is made, contact the Arizona State Historical Museum for removal and repatriation of the items.

POLICE DEPARTMENT SECURITY REQUIREMENTS:

- Refer to Tempe City Code Section 26-70 Security Plans.
- Design building entrance(s) to maximize visual surveillance of vicinity. Limit height of walls or landscape materials, and design columns or corners to discourage ambush.
- Maintain distances of 20'-0" or greater between a pedestrian path of travel and any hidden area to allow for increased reaction time and safety.
- Follow the design guidelines listed under appendix A of the Zoning and Development Code. In particular, reference the CPTED principal listed under A-II Building Design Guidelines (C) as it relates to the location of pedestrian environments and places of concealment.
- Provide a security vision panel at service and exit doors (except to rarely accessed equipment rooms) with a 3" wide high strength plastic or laminated glass window, located between 43" and 66" from the bottom edge of the door.

FIRE: Clearly define the fire lanes. Ensure that there is at least a 20'-0" horizontal width, and a 14'-0" vertical clearance from the fire lane surface to the underside of tree canopies or overhead structures. Layout and details of fire lanes are subject to Fire Department approval.

CIVIL ENGINEERING:

- Coordinate site layout with Utility provider(s) to provide adequate access easement(s).
- Clearly indicate property lines, the dimensional relation of the buildings to the property lines and the separation of the buildings from each other.

- Verify location of any easements, or property restrictions, to ensure no conflict exists with the site layout or foundation design.
- 100 year onsite retention required for this property, coordinate design with requirements of the Engineering Department.

#### SOLID WASTE SERVICES:

- Enclosure indicated on site plan is exclusively for refuse. Construct walls, pad and bollards in conformance with standard detail DS-116.
- Contact Public Works Sanitation Division to verify that vehicle maneuvering and access to the enclosure is adequate. Refuse staging, collection and circulation must be on site; no backing onto or off of streets, alleys or paths of circulation.
- Develop strategy for recycling collection and pick-up from site with Sanitation. Roll-outs may be allowed for recycled materials. Coordinate storage area for recycling containers with overall site and landscape layout.
- Gates for refuse enclosure(s) are not required, unless visible from the street. If gates are provided, the property manager must arrange for gates to be open from 6:00am to 4:30pm on collection days.

#### PARKING SPACES:

- Verify conformance of accessible vehicle parking to the Americans with Disabilities Act and the Code of Federal Regulations Implementing the Act. Refer to Building Safety ADA Accessible Parking Spaces Marking/Signage on Private Development details.
- At parking areas, provide demarcated accessible aisle for disabled parking.
- Distribute bike parking areas nearest to main entrance(s). Provide parking loop/rack per standard detail T-578. Provide 2'-0" by 6'-0" individual bicycle parking spaces. One loop may be used to separate two bike parking spaces. Provide clearance between bike spaces and adjacent walkway to allow bike maneuvering in and out of space without interfering with pedestrians, landscape materials or vehicles nearby.

#### ZONING AND DEVELOPMENT CODE:

- Specific requirements of the **Zoning and Development Code (ZDC)** are not listed as a condition of approval, but will apply to any application. To avoid unnecessary review time and reduce the potential for multiple plan check submittals, become familiar with the ZDC. Access the ZDC through [www.tempe.gov/zoning](http://www.tempe.gov/zoning) or purchase from Community Development.

#### LIGHTING:

- Design site security light in accordance with requirements of ZDC Part 4 Chapter 8 (Lighting) and ZDC Appendix E (Photometric Plan).
- Indicate the location of all exterior light fixtures on the site, landscape and photometric plans. Avoid conflicts between lights and trees or other site features in order to maintain illumination levels for exterior lighting.

#### LANDSCAPE:

- Prepare an existing plant inventory for the site and adjacent street frontages. The inventory may be prepared by the Landscape Architect or a plant salvage specialist. Note original locations and species of native and "protected" trees and other plants on site. Move, preserve in place, or demolish native or "protected" trees and plants per State of Arizona Agricultural Department standards. File Notice of Intent to Clear Land with the Agricultural Department. Notice of Intent to Clear Land form is available at [www.azda.gov/ESD/nativeplants.htm](http://www.azda.gov/ESD/nativeplants.htm). Follow the link to "applications to move a native plant" to "notice of intent to clear land".

SIGNS: Separate plan review process is required for signs in accordance with requirements of ZDC Part 4 Chapter 9 (Signs). Refer to [www.tempe.gov/signs](http://www.tempe.gov/signs).

DUST CONTROL: Any operation capable of generating dust, include, but not limited to, land clearing, earth moving, excavating, construction, demolition and other similar operations, that disturbs 0.10 acres (4,356 square feet) or more shall require a dust control permit from the Maricopa County Air Quality Department (MCAQD). Contact MCAQD at <http://www.maricopa.gov/aq/>.



**HISTORY & FACTS:**

- November 30, 1978 City Council approved the rezoning from AG, Agricultural Zoning District to the I-1 Light Industrial and I-2 General Industrial Zoning Districts on 154.3 acres.
- July 17, 2003 City Council approved a Development Agreement with Tait Development Inc. for Emerald Center.
- September 11, 2003 City Council approved a General Plan Land Use Map Amendment and Zoning Map Amendment, a Preliminary Planned area Development and three variances for Lots 1, 4 and 5. Lot 2 was excluded from this PAD. Council approved the request by IKEA Home Furnishings for a Final PAD for IKEA consisting of 342,105 s.f. building for retail space and 7,235 s.f. for a restaurant on 23.41 net acres located at 8425 S Emerald Drive.
- November 28, 2006 Development Review Commission approved a request for DICK'S SPORTING GOODS for a 70,000 s.f. building on 14.322 acres.
- September 30, 2011 Staff approved a Development Plan Review for a temporary use of this site for Lennar Homes Model of a new multi-generational product.
- October 14, 2014 Development Review Commission approved a request for TEXAS ROADHOUSE RESTAURANT for a 7,240 s.f. restaurant building.
- December 10, 2014 The Development Services Department staff administratively approved the request by **EMERALD CENTER AMENDED PAD FOR LOT 1B** for a Planned Area Development amendment for a new free-standing restaurant building located at 8510 South Emerald Drive in the RCC, Regional Commercial Center District.
- August 11, 2015 Development Review Commission approved a request for MATTRESS FIRM AT EMERALD CENTER for a 7,760 s.f. retail building.

**ZONING AND DEVELOPMENT CODE REFERENCE:**

Section 6-306, Development Plan Review



**DEVELOPMENT PROJECT FILE**  
for  
**GUITAR CENTER**  
**(PL160300)**

**ATTACHMENTS:**

1. Location Map
2. Aerial
3. Letter of Explanation
4. Site Plan
5. Landscape Plan
6. Blackline Building Elevations
7. Color Building Elevations
8. Building Sections
9. Floor Plan
10. Color Materials Board (actual board to be available at hearing)
- 11-12. Color Renderings
- 13-18. Site Context Photos

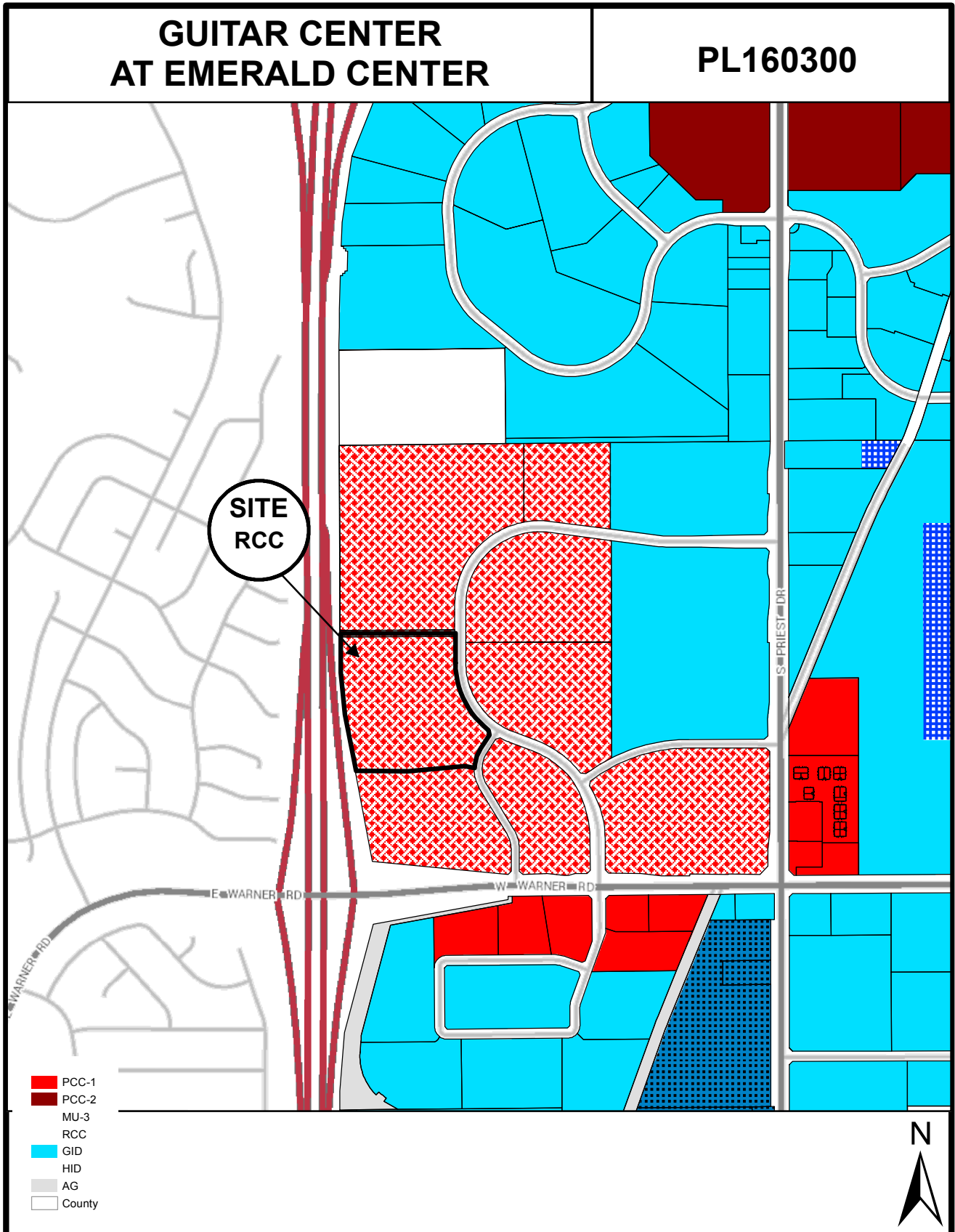

**Location Map**

**GUITAR CENTER  
AT EMERALD CENTER**

**PL160300**

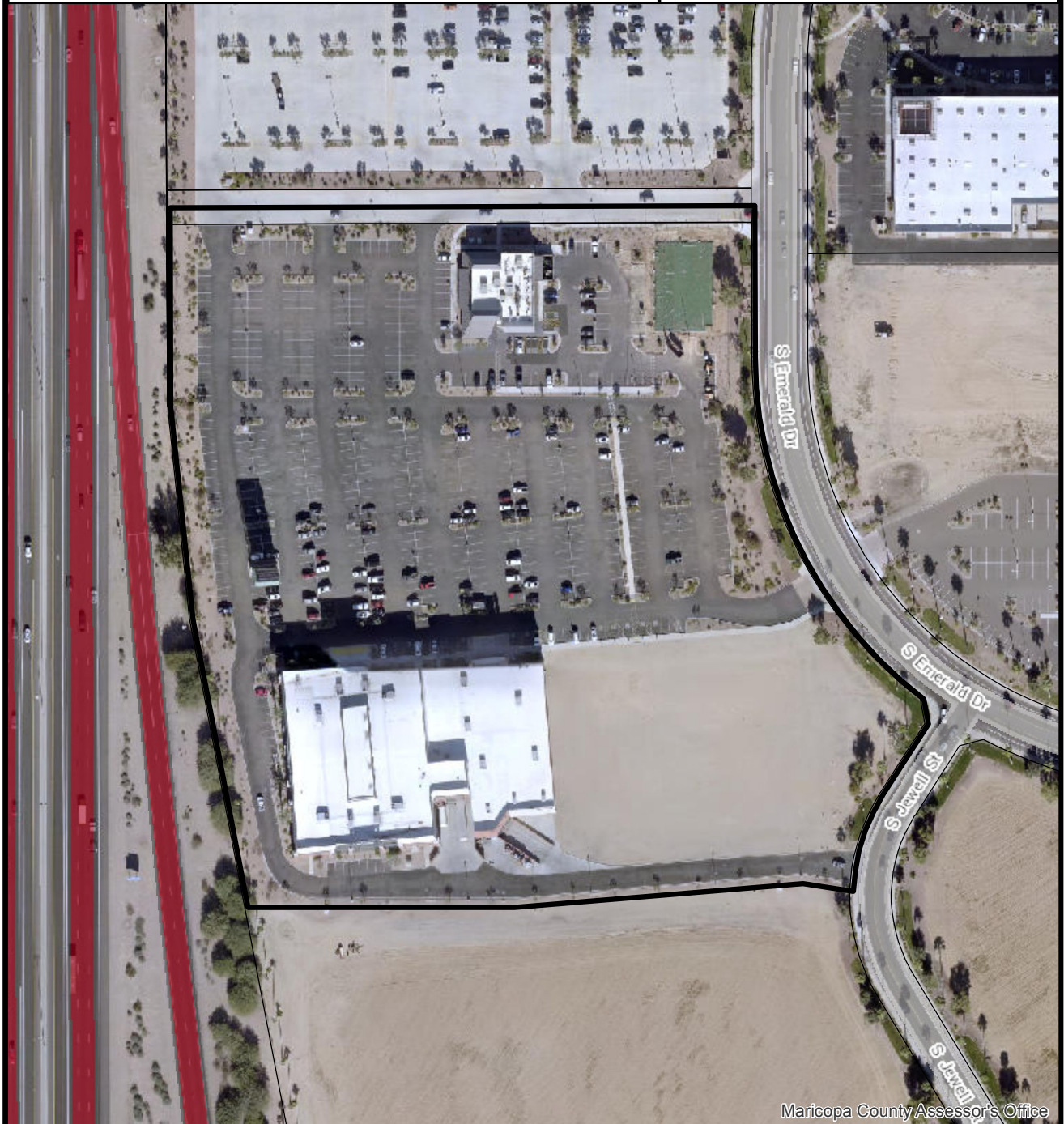

Maricopa County Assessor's Office

Aerials2016



**Aerial Map**

**Emerald Center – Guitar Center  
DRB Narrative**

**Introduction:**

LGE Corporation is requesting a Pre-application review for building design and site of a single building Retail Building located at the Emerald Center. The development is located within the Emerald Center at I-10 and Warner Road in Tempe, Arizona. The new structure will be directly adjacent (attached to) the East side of the Existing Total Wine store.

**Project Proposal:**

The site area is 50,793 S.F. (1.16 acres) and will have approximately 660 S.F. of new landscape area adjacent to the structure. The retail building has a total gross square footage of 15,321 S.F. (single story with building height of approximately +37'-8" A.F.F. / +38'-0" above grade).

**Building Design:**

The building design, colors and materials will match the adjacent existing structure utilizing brick, EIFs, pre cast concrete, and metal accents in conformity with the Emerald Center design standards for materials and colors. Low-E glazing will be utilized at the exterior where applicable at the storefront along with a steel canopy to match the adjacent building extends out over the main entrance doors. Three sided architecture is prevalent throughout the elevations with varying height parapets, wall offsets and colors to reduce continuous wall lengths.

**Site Design:**

Currently, the parking and pedestrian access (sidewalk) in front of the building is all existing, including ADA parking stalls and site lighting.

Vehicular access to the development is also exists.

Pedestrian access is provided via an existing sidewalk connection from the facility through a sidewalk located just north of the new building location. The existing sidewalks will be ADA accessible.

**Landscape Design:**

This project will have landscape along the frontage of the property. The landscape will consist of an ornamental desert theme, to match the existing landscaping of the Emerald Center.



**LEGAL DESCRIPTION**

LOT 8, A REPLAT OF LOT 1 AMENDED FINAL PLAN FOR THE EMERALD,  
A REPLAT OF LOT 1, ACCORDING TO BOOK 060 OF MAPS, PAGE 12,  
RECORDS OF MARICOPA COUNTY, ARIZONA

**PROJECT DATA:**

PROJECT ADDRESS: N.W.C. OF JEWEL ST. & EMERALD DR.  
EMERALD CENTER  
TEMPE, AZ

DEVELOPER: LGE DESIGN BUILD  
740 NORTH 52ND STREET  
PHOENIX, AZ 85008

PROJECT SCOPE: A NEW COMMERCIAL RETAIL BUILDING

ASSESSOR PARCEL NO.: 301-64-910A

CURRENT ZONING: RCC (RAD)  
MAX. BLDG. HT. ALLOWED - 75'-0"  
MAX. LOT COVERAGE - 50%  
MIN. LANDSCAPE AREA - 15%  
MIN. BUILDING SETBACK:  
FRONT - 25'-0"  
SIDE - 25'-0"  
REAR - 25'-0"  
MIN. PARKING SETBACK:  
FRONT - 20'-0"  
SIDE - 20'-0"

SITE AREA: 50,790 S.F. (1.16 AC)  
LANDSCAPE AREA: 600 S.F.  
LANDSCAPE COVERAGE: 1.18%

STORIES: ONE STORY  
BUILDING HEIGHT: +38'-0" ABOVE GRADE (+37'-8" ABOVE FIN.FLUR.)  
BUILDING S.F.: 15,321 S.F.  
CLEAR CLG HEIGHT: +20'-0"

LOT COVERAGE: 30.12%  
OCCUPANCY: M  
CONSTRUCTION TYPE: V-B  
FIRE SPRINKLERS: YES (FULLY SPRINKLED W/ A.F.E.S.)

REQUIRED PARKING CALCS:	SQUARE FT.	FACTOR	TOTAL
RETAIL	15,321 S.F.	1 / 300 S.F.	51 SPACES
PARKING PROVIDED			
REGULAR SPACES			40 SPACES
ACCESSIBLE SPACES			2 SPACES
TOTAL SPACES			81 SPACES
PARKING RATIO			0.33 CARS FOR 1,000 S.F.

NOTE: IN REGARDS TO PARKING REQUIRED/PROVIDED, ALL PARKING INCLUDING ACCESSIBLE SPACES ARE EXISTING AND AVAILABLE FOR USE AS PART OF THE OVERALL MASTER SITE DEVELOPMENT. REFER TO EXISTING OVERALL PARKING DATA BELOW ON THIS SHEET FOR AVAILABLE PARKING UNDER "FUTURE ALLOWED".

BICYCLE SPACES CALCS:	SQUARE FT.	FACTOR	TOTAL
RETAIL	15,321 S.F.	1 / 10,000 S.F. (2 MIN. SPACES)	2 BICYCLE SPACES REQUIRED
			2 BICYCLE SPACES PROVIDED

**EXISTING OVERALL PARKING DATA**

EXISTING SPACES ON SITE (CURRENT)

STANDARD STALLS	652 SPACES
ACCESSIBLE STALLS	21 SPACES
TOTAL STALLS	683 SPACES

PARKING SPACES ALLOCATION (CURRENT)

PHASE/TENANT	SPACES
DICK'S SPORTING GOODS	229 SPACES
TOTAL WINE	79 SPACES
TEXAS ROAD HOUSE	95 SPACES
MATTRESS FIRM	14 SPACES
FUTURE ALLOWED (SUB-TOTAL)	170 SPACES
	567 SPACES

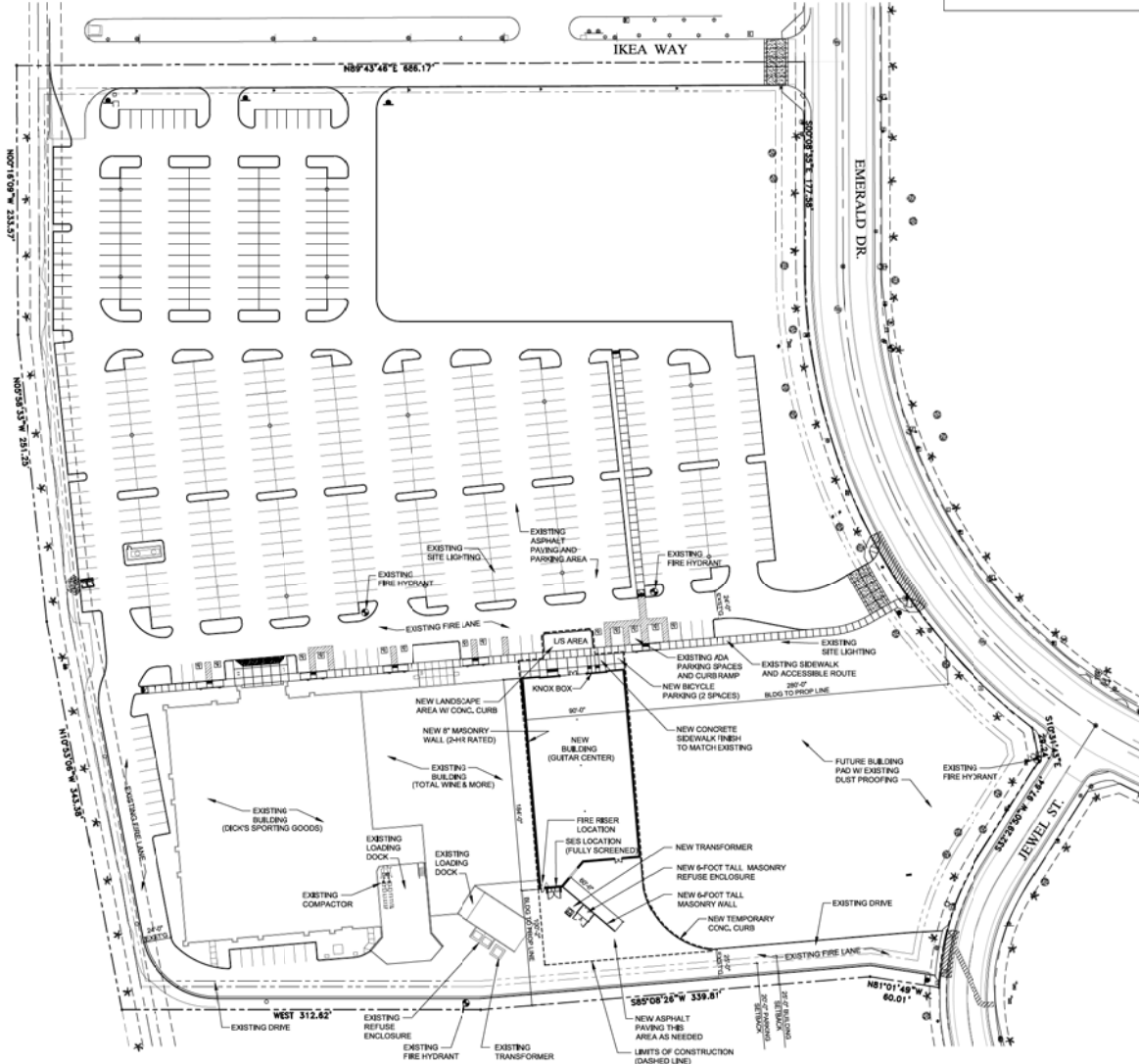

PRELIMINARY SITE PLAN

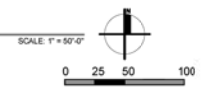

VICINITY MAP

**LGE DESIGN GROUP**  
740 N. 52nd Street • Phoenix, AZ • 85008  
P. 480.966.4001

**GUITAR CENTER AT EMERALD CENTER**  
N.W.C. OF JEWEL STREET & EMERALD DRIVE  
TEMPE, ARIZONA 85284

**LGE DESIGN BUILD**

NUMBER	REVISION	DATE

PRELIMINARY NOT FOR CONSTRUCTION

SHEET TITLE: SITE PLAN  
ISSUE DATE: 08-22-16  
DRAWN BY: BCR/JFM  
CHECKED BY: VJD  
PROJECT No: 000016  
SHEET:

**A0.1**

DRB ISSUE 08-22-2016

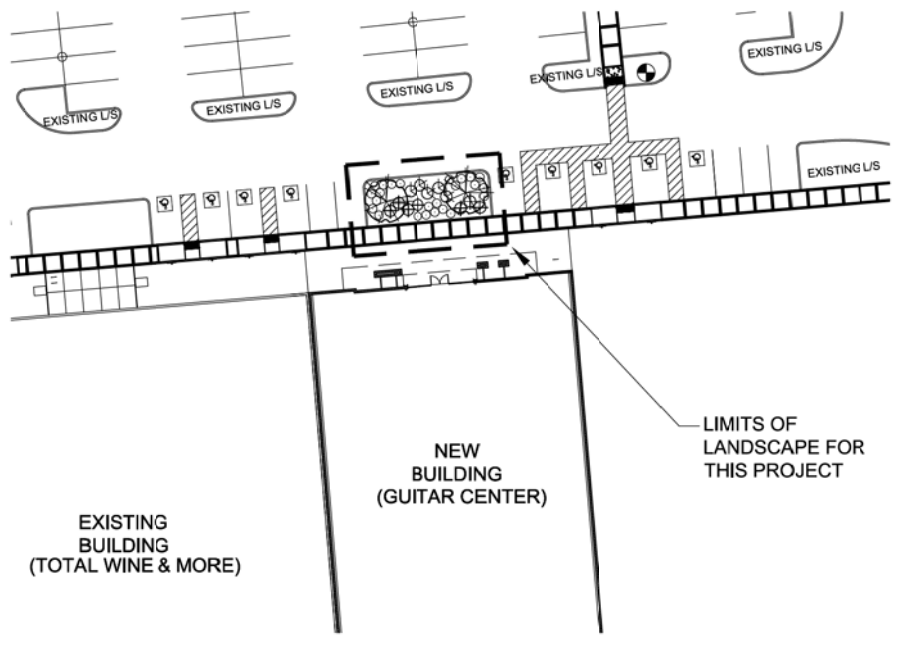

**LANDSCAPE LEGEND**

- OLEA EUROPEA 'SWAN HILL'  
SWAN HILL OLIVE  
36" BOX (MATCHING)
- MUHLENBERGIA RIGENS  
DEER GRASS  
5 GALLON
- HESPERALOE PARVIFLORA  
RED YUCCA  
5 GALLON
- LANTANA MONTEVIDENSIS  
'GOLD MOUND'  
1 GALLON
- MATCH EXISTING  
DECOMPOSED GRANITE  
2" DEPTH IN ALL LANDSCAPE AREAS

**PROJECT DATA:**

PROJECT ADDRESS:	GUITAR CENTER EMERALD CENTER TEMPE, AZ
DEVELOPER:	LOE EISEN BLDG 740 NORTH 52ND STREET PHOENIX, AZ 85009
PROJECT SCOPE:	A NEW COMMERCIAL RETAIL BUILDING
ASSESSOR PARCEL NO.:	301-54410A
CURRENT ZONING:	RCC (RAD) MAX BLDG HT. ALLOWED - 70'-0" MAX LOT COVERAGE - 50% MIN LANDSCAPE AREA - 15% MIN BUILDING SETBACK: FRONT - 25'-0" SIDE - 25'-0" REAR - 25'-0" MIN PARKING SETBACK: FRONT - 20'-0" SIDE - 20'-0"
SITE AREA:	50,793 S.F. (1.16 AC)
LANDSCAPE AREA:	860 S.F.
LANDSCAPE COVERAGE:	1.18%
STORIES:	ONE STORY
BUILDING HEIGHT:	+38'-0" ABOVE GRADE (+37'-4" ABOVE FIN.FL.)
BUILDING S.F.:	15,321 S.F.
CLEAR CLG HEIGHT:	+20'-0"
LOT COVERAGE:	30.12 %
OCCUPANCY:	M
CONSTRUCTION TYPE:	V-8 W A.F.E.S.

  

REQUIRED PARKING CALCS:	SQUARE FT.	FACTOR	TOTAL
RETAIL	15,321 S.F.	1 / 300 S.F.	51 SPACES
PARKING PROVIDED			
TOTAL REGULAR SPACES			49
TOTAL ACCESSIBLE SPACES			2
TOTAL SPACES			51
PARKING RATIO		0.33 CARS FOR 1,000 S.F.	

NOTE: IN REGARDS TO PARKING REQUIRED/PROVIDED, ALL PARKING INCLUDING ACCESSIBLE SPACES ARE EXISTING AND AVAILABLE FOR USE AS PART OF THE OVERALL MASTER SITE DEVELOPMENT. REFER TO EXISTING OVERALL PARKING DATA BELOW ON THIS SHEET FOR AVAILABLE PARKING UNDER "FUTURE ALLOWED".

BICYCLE SPACES CALCS:	SQUARE FT.	FACTOR	TOTAL
RETAIL	15,321 S.F.	1 / 10,000 S.F. (2 MIN. SPACES)	2 BICYCLE SPACES REQUIRED 2 BICYCLE SPACES PROVIDED

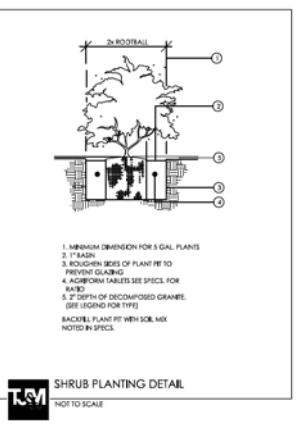
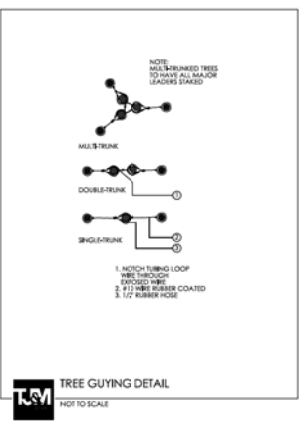
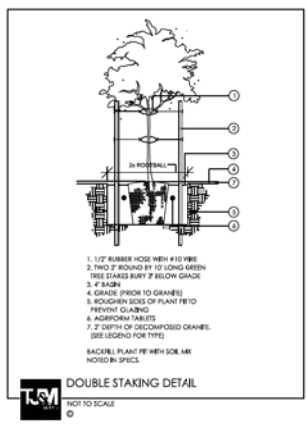

NUMBER	REVISION	DATE



**T.J. McQUEEN & ASSOCIATES, INC.**  
LANDSCAPE ARCHITECTURE  
URBAN DESIGN  
SITE PLANNING

8433 East Cholla St., Suite 101  
Scottsdale, Arizona 85260  
P: (602) 265-0320 F: (602) 266-6619  
EMAIL: [tjmcqueen@tjma.com](mailto:tjmcqueen@tjma.com)



SHEET TITLE: LANDSCAPE PLAN  
ISSUE DATE: 08.18.16  
DRAWN BY: BCR / JPM  
CHECKED BY: VJD  
PROJECT NO.:  
SHEET: 000016

**La.01**

**NORTH ELEVATION**

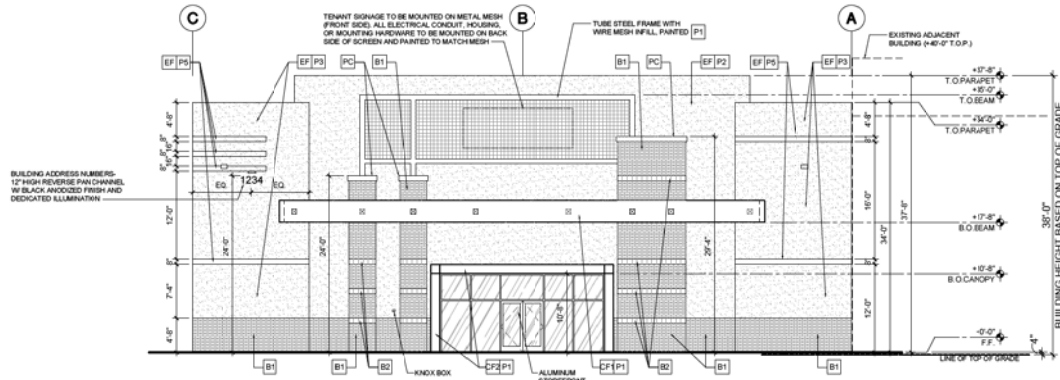

SCALE: 1/8" = 1'-0"

**EAST ELEVATION**

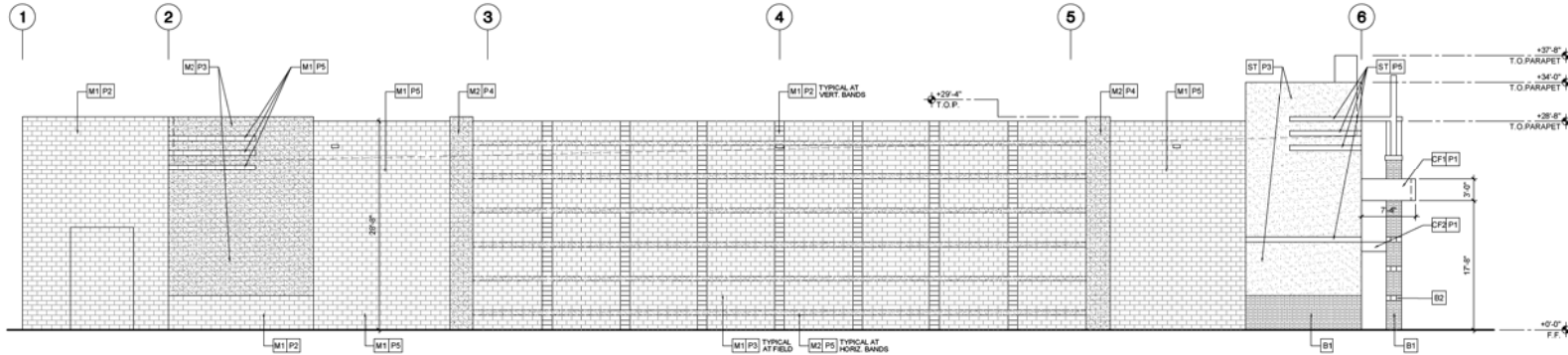

SCALE: 1/8" = 1'-0"

**SOUTH ELEVATION**

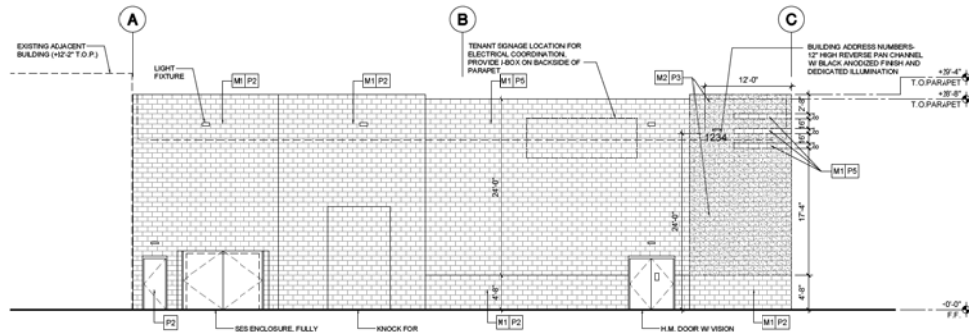

SCALE: 1/8" = 1'-0"

**GENERAL NOTES:**

- SEE STRUCTURAL DRAWINGS FOR LINTEL INFORMATION.
- SEE DOOR SCHEDULE FOR ROLL-UP DOOR HEIGHTS.
- SEE STRUCTURAL DRAWINGS FOR CONTROL JOINT LOCATIONS.

**MATERIAL/FINISH SCHEDULE:**

KEY	DESCRIPTION
M1	8"x8" SMOOTH FACE MASONRY
M2	8"x8" SPLIT FACE MASONRY
B1	BRICK VENEER - FIELD - BELDEN #803-S&S STANDING WITH #127 LAFARGE MASONRY COLORED MORTAR
B2	BRICK VENEER - ACCENT - BELDEN #8" SEA GREY SMOOTH WITH MATCHING COLORED MORTAR
ST	STUCCO OVER BLOCK
EF	FRAMING WITH EIFS FINISH
PC	8" HIGH INTEGRAL COLORED PRECAST CONC. CAP

**CANOPY KEY:**

KEY	DESCRIPTION
CF1	STEEL TUBE EYEBROW FRAME WITH APPLIED STEEL ACCENT MEDALLIONS AS DEPICTED
CF2	STEEL WIDE FLANGE ENTRY COVER WITH TOP TO HAVE 1" DECK AND UNDERSIDE TO BE ACM METAL PANEL. PAINTED TO MATCH WIDE FLANGE BEAMS

**GLAZING KEY:**

MATERIAL	DESCRIPTION
FRAMES	ARCADIA DARK BRONZE (A-B) TO MATCH ADJACENT EXISTING STOREFRONT
EXTERIOR GLAZING	1" CLEAR INSULATED GLAZING

**PAINT KEY:**

NOTE: PAINT MANUFACTURER TO BE DUNN EDWARDS. COLOR MATCH PAINTS LISTED BELOW AS NEEDED. ALL PAINTS TO EXISTING BUILDING COLORS AS CLOSE AS POSSIBLE.

KEY	DESCRIPTION
P1	DUNN EDWARDS - MATCH DICK'S SPORTING GOODS GREEN FROM SHERWIN WILLIAMS (SIMILAR TO COUNTRY SQUARE #EW 5475 - LRV 6)
P2	DUNN EDWARDS - MATCH FRAZEE 'ANTHEM' #CLV 1111N - LRV 11
P3	DUNN EDWARDS - MATCH DRYVIT COLOR MONASTERY BROWN #B1 - LRV 35
P4	DUNN EDWARDS 'GRANDE HALL' #DET595 - LRV 19
P5	DUNN EDWARDS 'BARNWOOD GRAY' #DET620 - LRV 31

**PAINTING NOTES:**

- PAINTER TO PROVIDE FOUR COLOR SCHEME WITH ALL DECORATIVE BANDS MASKED AND PAINTED IN COLORS TO BE SELECTED.
- SEALANT'S FOR THE PROJECT TO MATCH ADJACENT MATERIAL COLORS - NO WHITE OR OFF WHITE COLORS.
- PAINTER TO PREPARE SAMPLES WITH APPROPRIATE COLOR TO BE APPROVED BY OWNER PRIOR TO APPLICATION ON BUILDING FACADES.
- PAINTER TO PROVIDE TWO COATS OF SEALER TO ALL EXPOSED NATURAL BLOCK, PRECAST CONCRETE, UNPAINTED CONCRETE AND OTHER MATERIALS AS REQUIRED TO PROVIDE A WEATHER SEALED PROJECT.

NUMBER	REVISION	DATE

**PRELIMINARY NOT FOR CONSTRUCTION**

SHEET TITLE	DATE
EXTERIOR ELEVATIONS	08-22-16
ISSUE DATE:	08-22-16
DRAWN BY:	BCR / JRM
CHECKED BY:	V.J.D.
PROJECT No:	000016
SHEET:	000016

**A2.1**



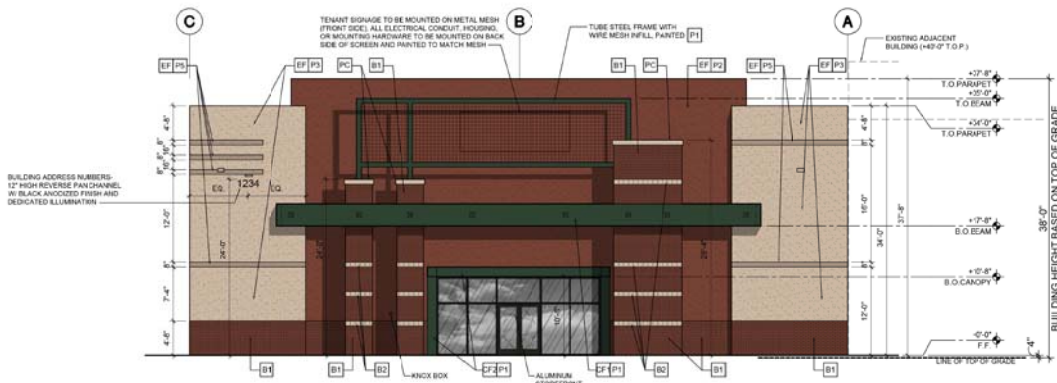

**NORTH ELEVATION**

SCALE: 1/8" = 1'-0"

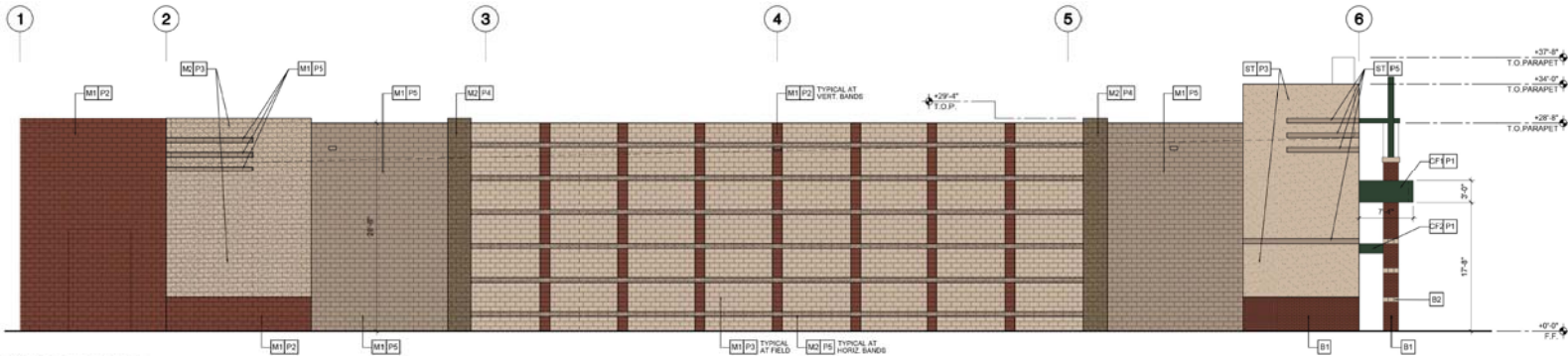

**EAST ELEVATION**

SCALE: 1/8" = 1'-0"

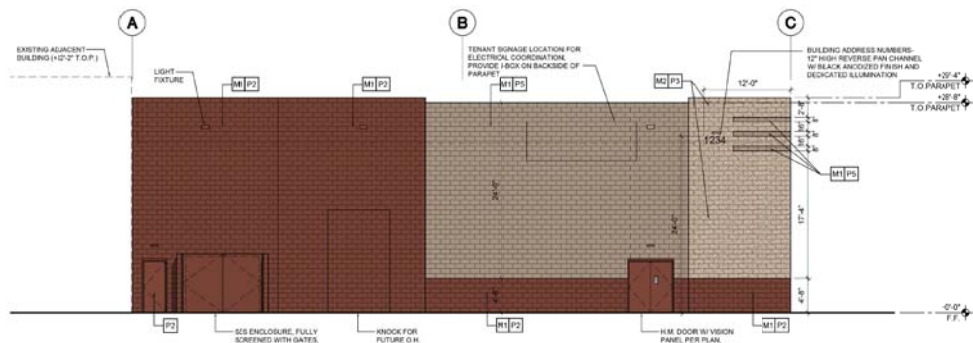

**SOUTH ELEVATION**

SCALE: 1/8" = 1'-0"

**GENERAL NOTES:**

- SEE STRUCTURAL DRAWINGS FOR LINTEL INFORMATION.
- SEE DOOR SCHEDULE FOR ROLL-UP DOOR HEIGHTS.
- SEE STRUCTURAL DRAWINGS FOR CONTROL JOINT LOCATIONS.

**MATERIAL/FINISH SCHEDULE:**

KEY:	DESCRIPTION:
M1	8"x8"x16" SMOOTH FACE MASONRY
M2	8"x8"x16" SPLIT FACE MASONRY
B1	BRICK VENEER - FIELD - BELDEN #303 SEA GREY STANDING WITH #17 LAFARGE MASONRY COLORED MORTAR.
B2	BRICK VENEER - ACCENT - BELDEN #8"x8" SEA GREY SMOOTH WITH MATCHING COLORED MORTAR.
BT	STUCCO OVER BLOCK
EF	FRAMING WITH EF'S FINISH
PC	8" HIGH INTEGRAL COLORED PRECAST CONC. CAP

**CANOPY KEY:**

KEY:	DESCRIPTION:
CF1	STEEL TUBE EYEBROW FRAME WITH APPL. STEEL ACCENT MEDALLIONS AS DEPICTED
CF2	STEEL WIDE FLANGE ENTRY COVER WITH TOP TO HAVE "F" DECK AND UNDERSIDE TO BE ACM METAL PANEL. PAINTED TO MATCH WIDE FLANGE BEAMS

**GLAZING KEY:**

MATERIAL:	DESCRIPTION:
FRAMES	ARCADIA DARK BRONZE (#8-7) TO MATCH ADJACENT EXISTING STONEFRONT
EXTERIOR GLAZING	1" CLEAR INSULATED GLAZING

**PAINT KEY:**

NOTE: PAINT MANUFACTURER TO BE DUNN EDWARDS. COLOR MATCH PAINTS LISTED BELOW AS NEEDED. ALL PAINTS TO EXISTING BUILDING COLORS AS CLOSE AS POSSIBLE.

KEY:	DESCRIPTION:
P1	DUNN EDWARDS - MATCH DICK'S SPORTING GOODS GREEN FROM SHERWIN WILLIAMS (SIMILAR TO 'COUNTRY SQUARE' #89-R475 - LRV 6)
P2	DUNN EDWARDS - MATCH FRAZEE 'ANTHEM' #JLV 1111N - LRV 11
P3	DUNN EDWARDS - MATCH DRYVIT COLOR MONASTERY BROWN #301 - LRV 35
P4	DUNN EDWARDS 'GRANGE HALL' #DET695 - LRV 19
P5	DUNN EDWARDS 'BARWOOD GRAY' #DET620 - LRV 31

**PAINTING NOTES:**

- PAINTER TO PROVIDE FOUR COLOR SCHEME WITH ALL DECORATIVE BANDS MASKED AND PAINTED IN COLORS TO BE SELECTED.
- SEALANTS FOR THE PROJECT TO MATCH ADJACENT MATERIAL COLORS - NO WHITE OR OFF WHITE COLORS.
- PAINTER TO PREPARE SAMPLES WITH APPROPRIATE COLOR TO BE APPROVED BY OWNER PRIOR TO APPLICATION ON BUILDING FACADES.
- PAINTER TO PROVIDE TWO COATS OF SEALER TO ALL EXPOSED NATURAL BLOCK, PRECAST CONCRETE, UNPAINTED CONCRETE AND OTHER MATERIALS AS REQUIRED TO PROVIDE A WEATHER SEALED PROJECT.

NUMBER	REVISION	DATE

**PRELIMINARY NOT FOR CONSTRUCTION**

SHEET TITLE	
EXTERIOR ELEVATIONS	
ISSUE DATE:	08-22-15
DRAWN BY:	BCR/JHM
CHECKED BY:	VJD
PROJECT No.:	000015
SHEET:	

**A2.1**

NUMBER	REVISION	DATE

PRELIMINARY  
 NOT FOR  
 CONSTRUCTION

SHEET TITLE	
BUILDING SECTION	
ISSUE DATE:	08-22-16
DRAWN BY:	BCR / JSM
CHECKED BY:	VJD
PROJECT No:	000016
SHEET:	

**A3.1**

DRB ISSUE 08-22-2016

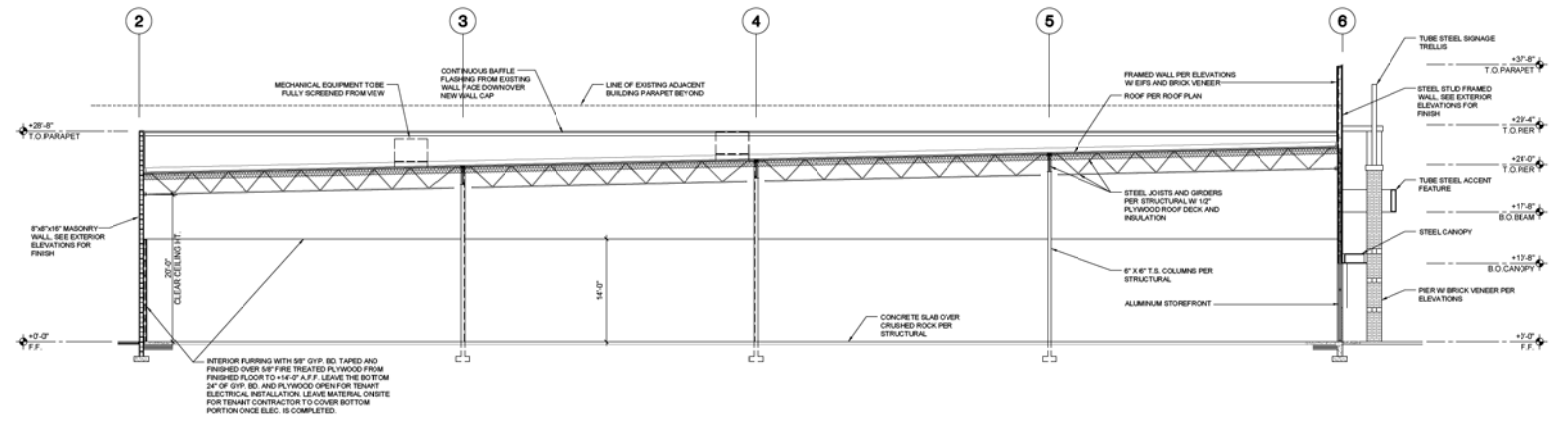

PRELIMINARY BUILDING SECTION

SCALE: 1/8" = 1'-0"

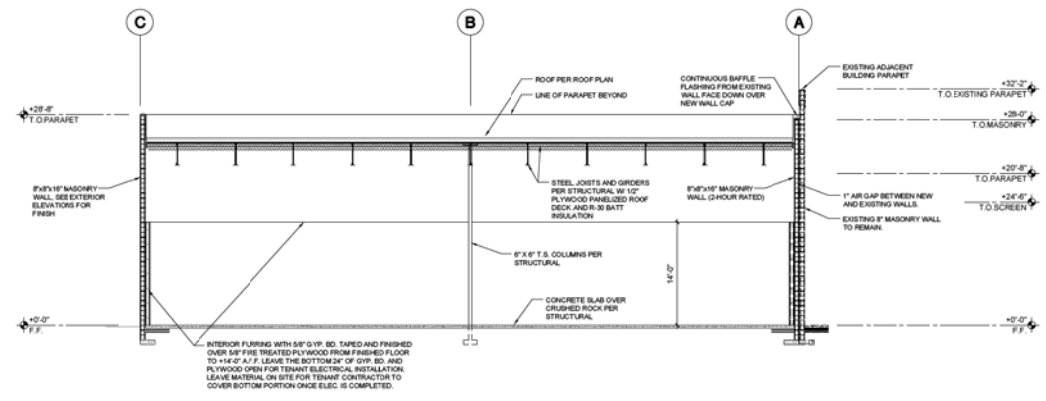

PRELIMINARY BUILDING SECTION

SCALE: 1/8" = 1'-0"

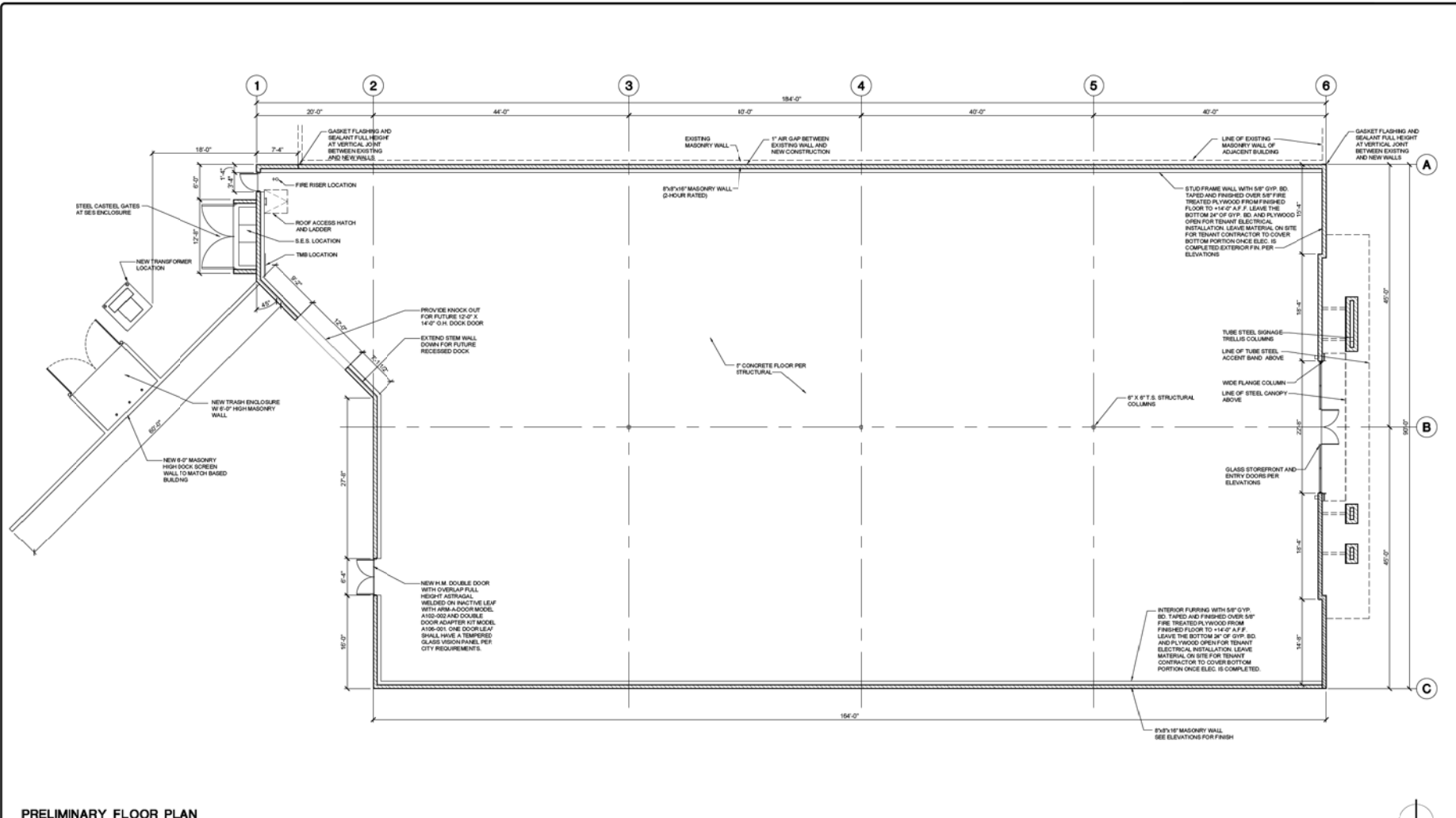

PRELIMINARY FLOOR PLAN

SCALE: 1/8" = 1'-0"



- PLAN NOTES:**
- FLOORING:**
    - 1. CONCRETE FLOOR TO BE UNSEALED.
  - CEILING:**
    - 1. PROVIDE R-30 BATT INSULATION AT UNDERSIDE OF ROOF STRUCTURE.
  - DOORS / WINDOWS:**
    - 1. EXTERIOR REAR MAN DOORS TO BE STEEL DOORS IN HOLLOW METAL FRAME.
  - MECHANICAL / PLUMBING:**
    - 1. ALL SPACE TO BE AIR CONDITIONED.
  - ELECTRICAL:**
    - 1. PROVIDE SINGLE LAMP METAL HALIDE WALL PACKS, BUILDING MOUNTED FOR SECURITY LIGHTING FULL PERIMETER OF THE EXTERIOR TO MATCH EXISTING.
    - 2. PROVIDE 2x1 LAMP FLUORESCENT LIGHTING W/ EMERGENCY BATTERY BACKUP AT EXTERIOR EXIT DOORS.
    - 3. ALL EXTERIOR LIGHTING TO BE CONTROLLED VIA A PHOTOCELL (DUSK TO DAWN) OR TIMECLOCK.
    - 4. PROVIDE CONDUIT AND J-BOX FOR FUTURE TENANT SIGNAGE.
    - 5. PROVIDE 480V/3PH, 3-PHASE WITH BOUNDARIES TO THE SPACE. MINIMUM IF AVAILABLE POWER SOURCE IS 200Y/120V, 3-PHASE THE SERVICE SHALL BE 200AMP'S MINIMUM.
    - 6. PROVIDE 2" CONDUIT WITH FULL STRONG TO TENANTS TELCO-DATA ROOM.
  - MISC:**
    - 1. PLEASE SEE THE RELATED LANDLORD WORK LETTER FOR ADDITIONAL DATA AND INFORMATION.

NUMBER	REVISION	DATE

PRELIMINARY NOT FOR CONSTRUCTION

SHEET TITLE	FLOOR PLAN
ISSUE DATE:	08-22-16
DRAWN BY:	BCR / JFM
CHECKED BY:	VJD
PROJECT No:	000016
SHEET:	

**A1.1**



P1 - Match Dick's Sporting goods green from Sherwin Williams  
SIM: Country Squire SW6475 - LRV6



P2 - Match 'Frazee' Anthem CLV 1111N - LRV11



P3 - Match 'Dryvit' Monastery Brown #381 - LRV 35



P4 - Grange Hall DET695 - LRV 19  
Dunn Edwards



P5 - Barnwood Gray DET620 - LRV 31  
Dunn Edwards

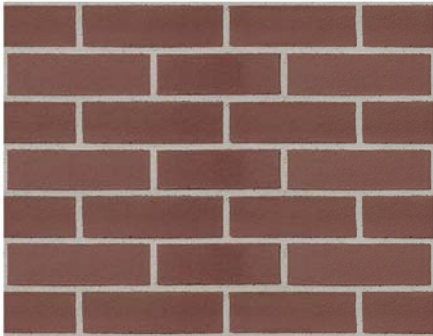

B1 - Brick Veneer - Accent - Belden 8"x8" Sea Gray smooth with Matching color Mortar



Anodized Aluminum Storefront  
Dark Bronze (AB-7)  
Arcadia



Glass  
Clear



Rendering View





Tempe, Arizona  
2016 . 08 . 19

**LGE** DESIGNGROUP

RENDERING VIEW

This artist rendering is for conceptual design only and should not be referred to as a construction document.  
THESE DRAWINGS ARE AN INSTRUMENT OF SERVICE AND THE PROPERTY OF LGE DESIGN GROUP AND LGE DESIGN BUILD AND SHALL REMAIN THEIR PROPERTY. THE USE OF THIS DRAWING SHALL BE RESTRICTED TO THE ORIGINAL SITE FOR WHICH IT WAS PREPARED AND PUBLICATION THEREOF IS EXPRESSLY LIMITED TO SUCH.







Tempe, Arizona  
2016 . 08 . 19

**LGE** DESIGNGROUP

RENDERING VIEW

This artist rendering is for conceptual design only and should not be referred to as a construction document.  
THESE DRAWINGS ARE AN INSTRUMENT OF SERVICE AND THE PROPERTY OF LGE DESIGN GROUP AND LGE DESIGN BUILD AND SHALL REMAIN THEIR PROPERTY. THE USE OF THIS DRAWING SHALL BE RESTRICTED TO THE ORIGINAL SITE FOR WHICH IT WAS PREPARED AND PUBLICATION THEREOF IS EXPRESSLY LIMITED TO SUCH.





# CONTEXT PHOTO PLAN















8

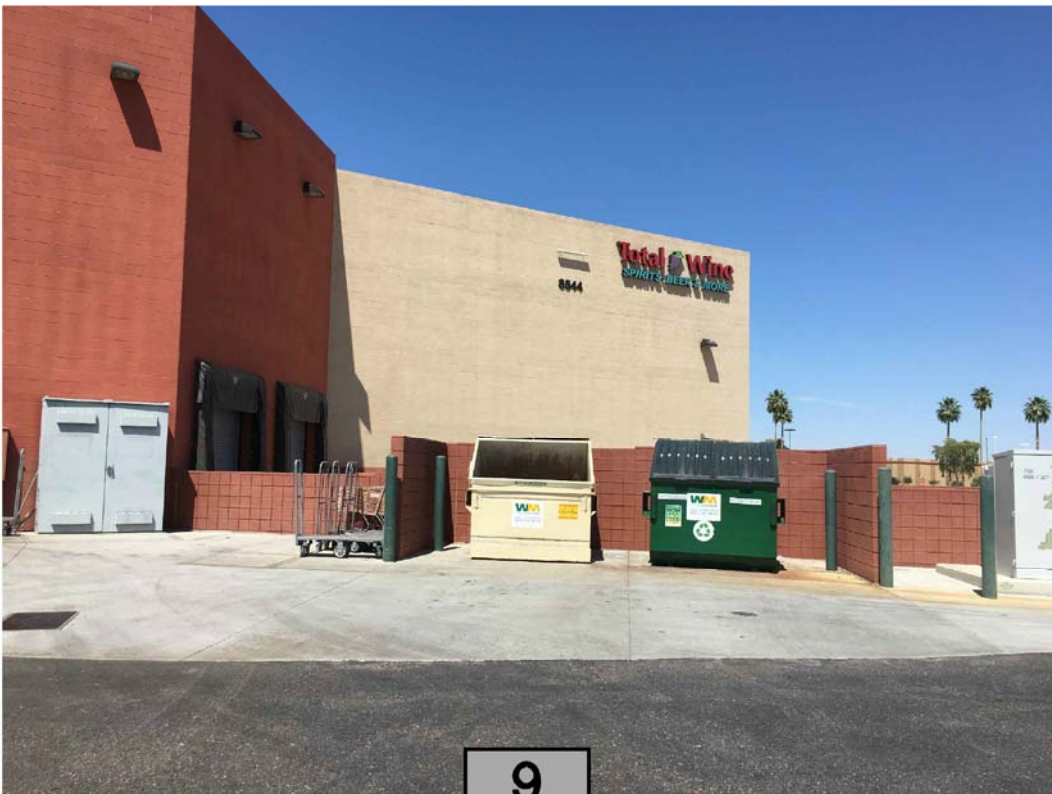

9





10



11